



D Montageanleitung

F Notice de montage

NL Handleiding voor de montage

CZ Monzázní návod

HU Szereelési útmutató

TR Montaj talimatı

GB Assembly instructions

I Istruzione di montaggio

PL Instrukcja montaży

SK Návod na montáž

RO Instrucțiuni de montaj

RU ИНСТРУКЦИЯ ПО МОНТАЖУ

Art. Nr. 1041-Lö

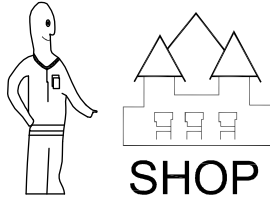
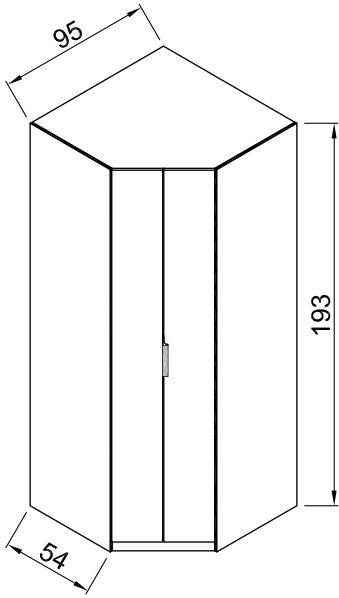

Art. Nr. 1041

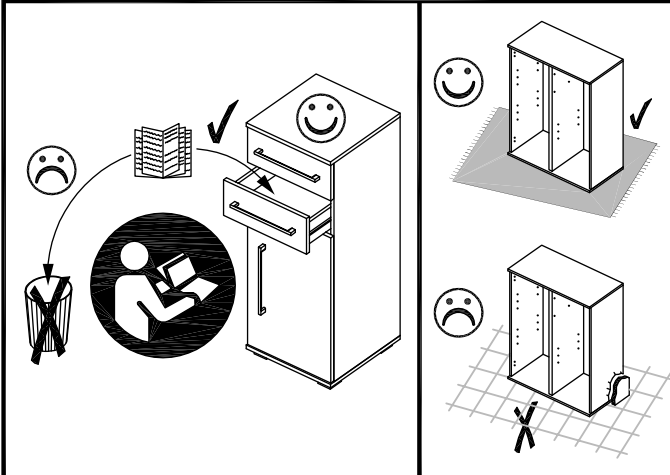
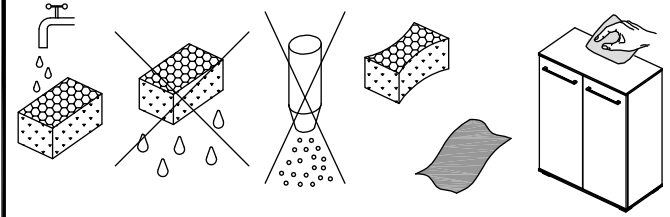
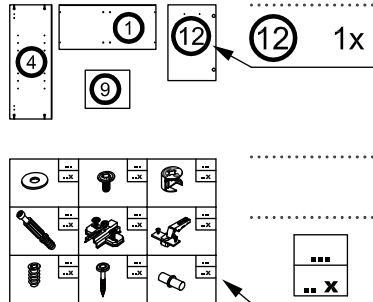

62 12x	72 7x	108 6x
3,5 x 13	4x13	
142 8x	143 8x	222 12x
Ø 15 x 11,5	6 x 44	4,5 x 55
295 2x	297 1x	364 6x
563 mm	1834 mm	
928 2x	575 1x	903 12x
4 x 15		Ø 12 / 2,5
908 4x	916 28x	921 8x
927 8x	928 12x	941 4x
6,3 x 11	4 x 15	

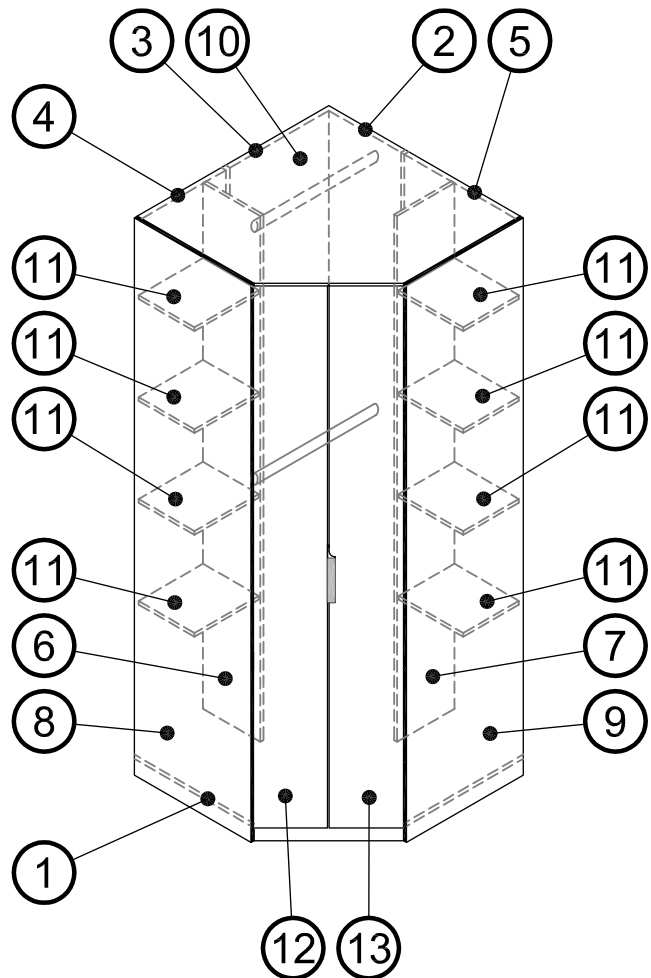

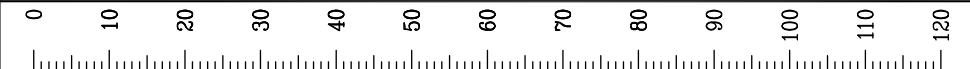
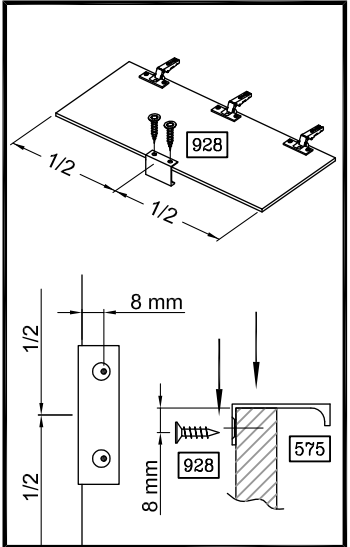
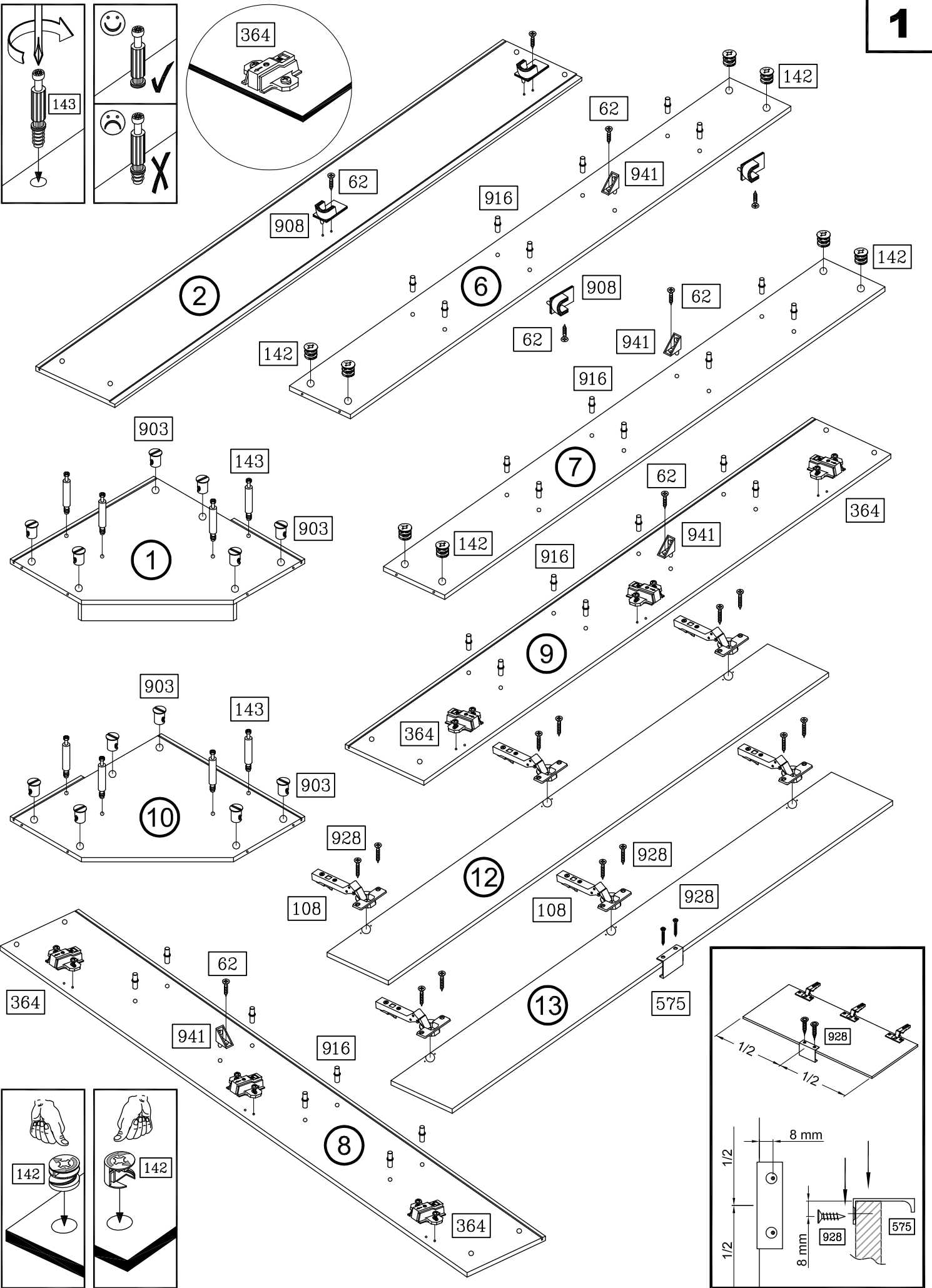
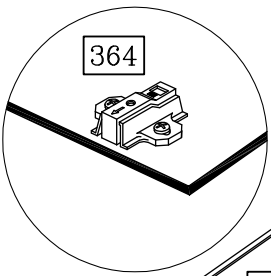
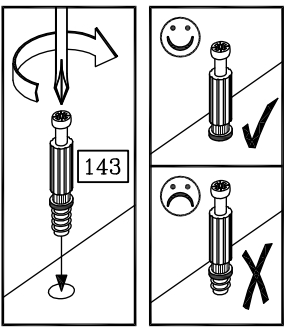

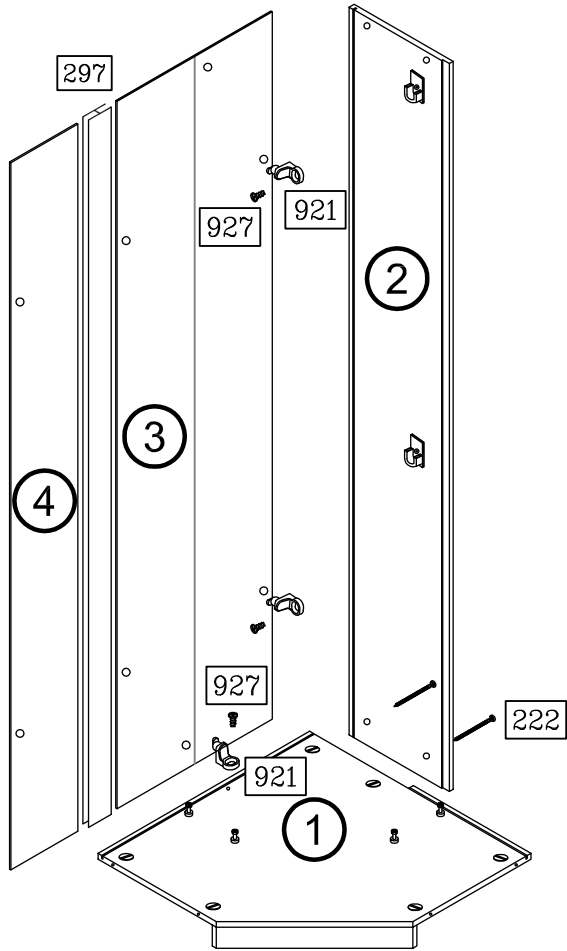
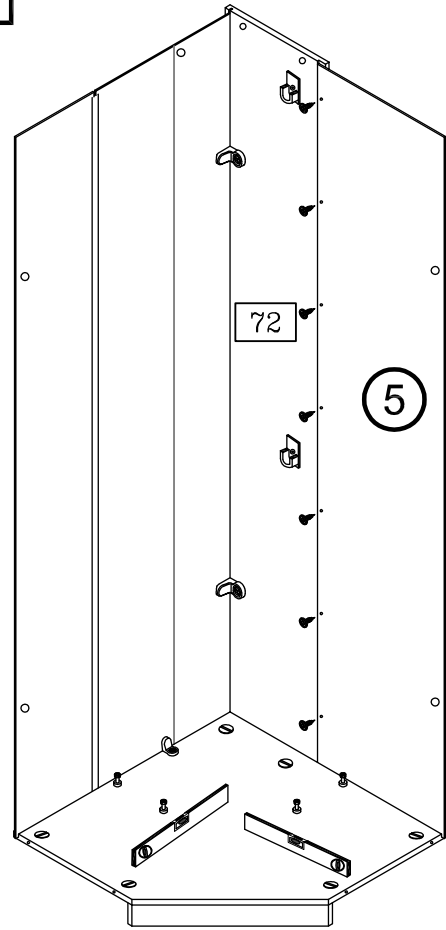
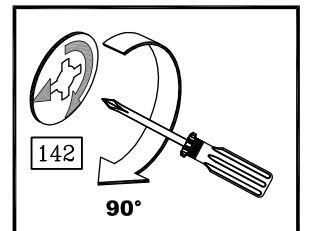
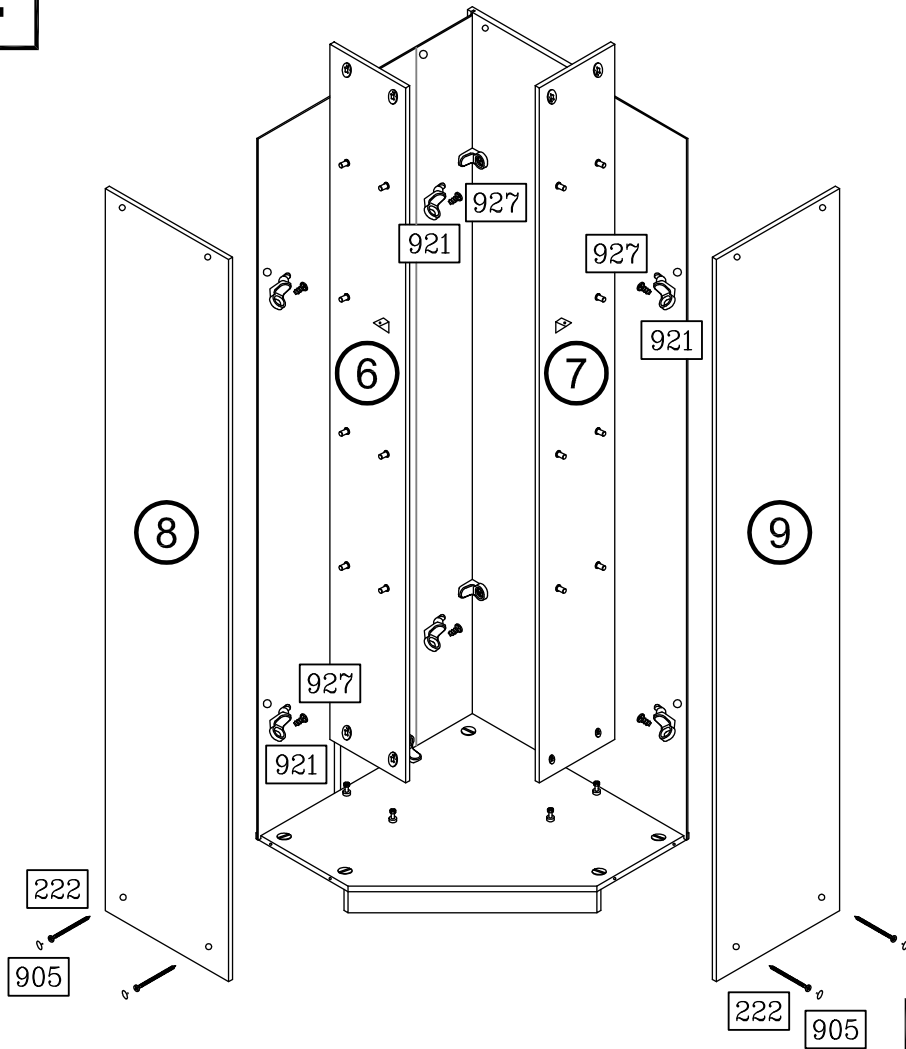
2**3****4**

1041-Lö-5

3/4

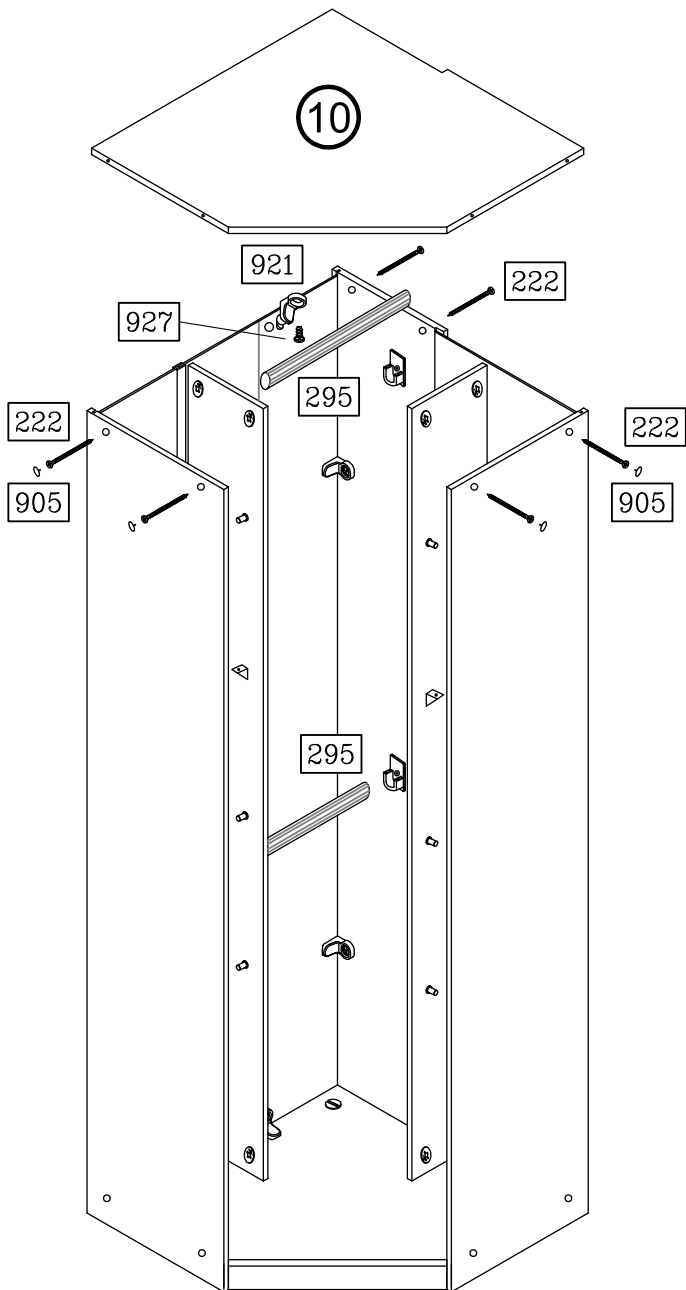
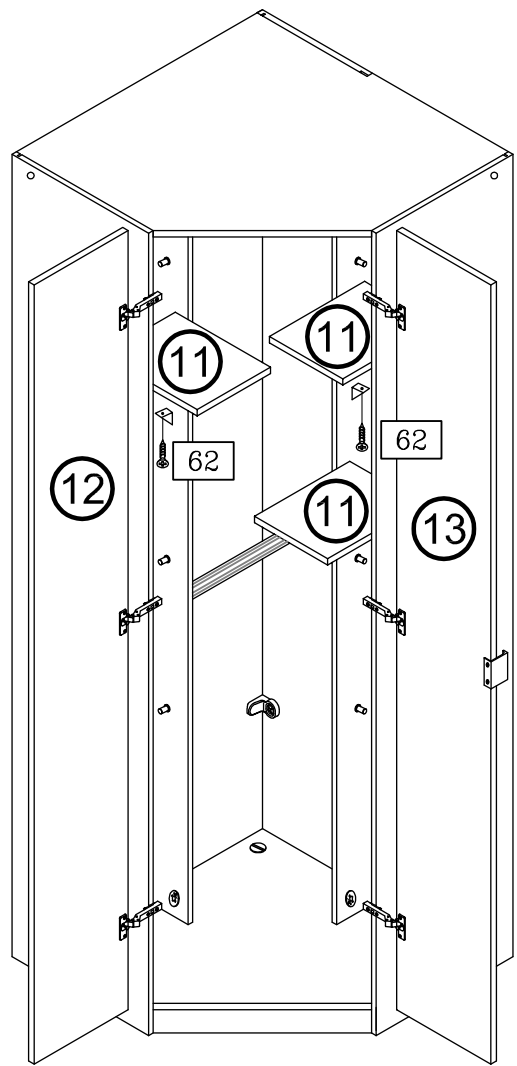
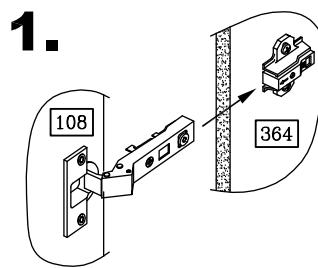
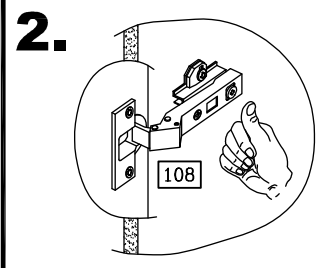
5**6****1.****2.****7**