



D Montageanleitung

F Notice de montage

NL Handleiding voor de montage

CZ Montážní návod

HU Szereelési útmutató

TR Montaj talimatı

GB Assembly instructions

I Istruzione di montaggio

PL Instrukcja montaży

SK Návod na montáž

RO Instrucțiuni de montaj

RU ИНСТРУКЦИЯ ПО МОНТАЖУ

Art. Nr. 3260

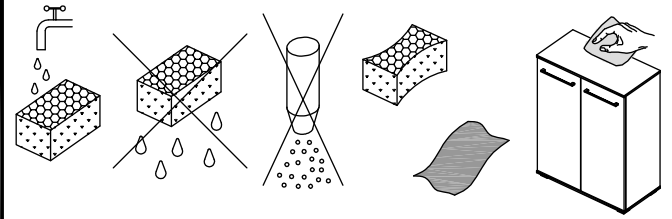
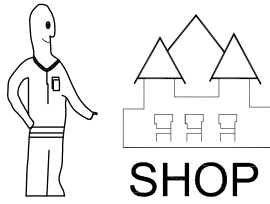
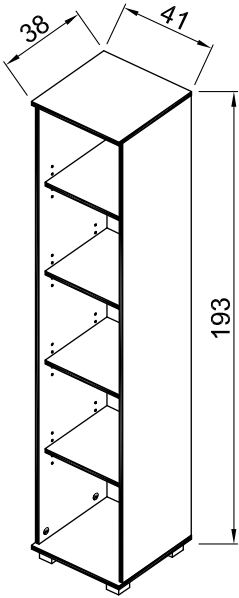

Art. Nr. 3260

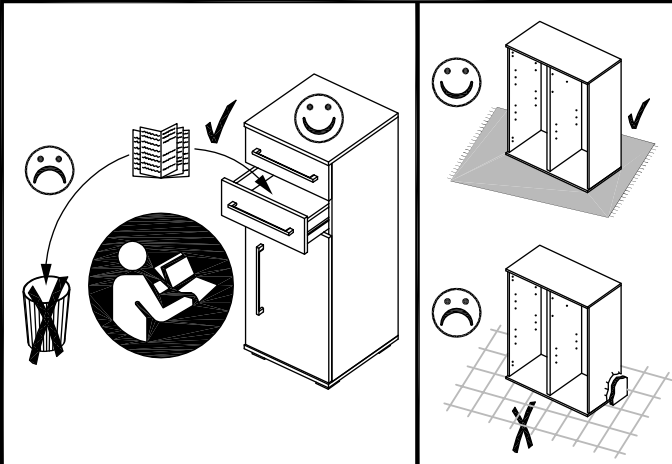
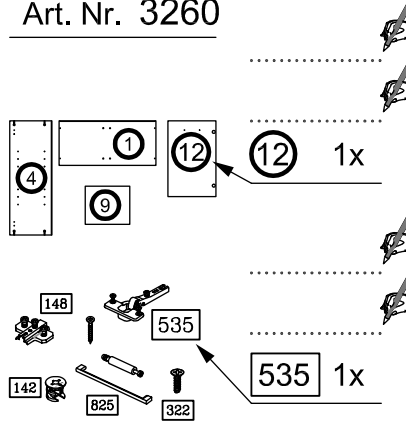

 3,5 x 35 102 8x	 Ø 15 x 11,5 142 8x
 6 x 44 143 8x	 528 4x
 2,7 x 20 906 44x	 916 16x

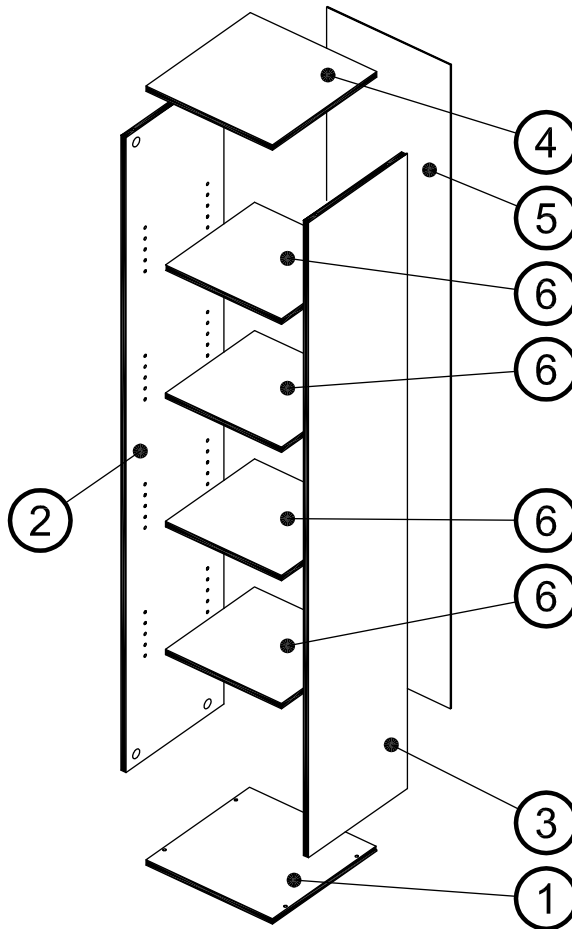

1

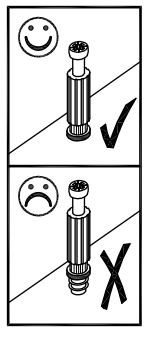
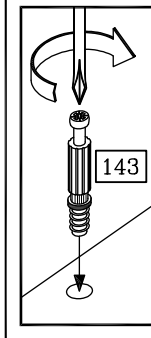
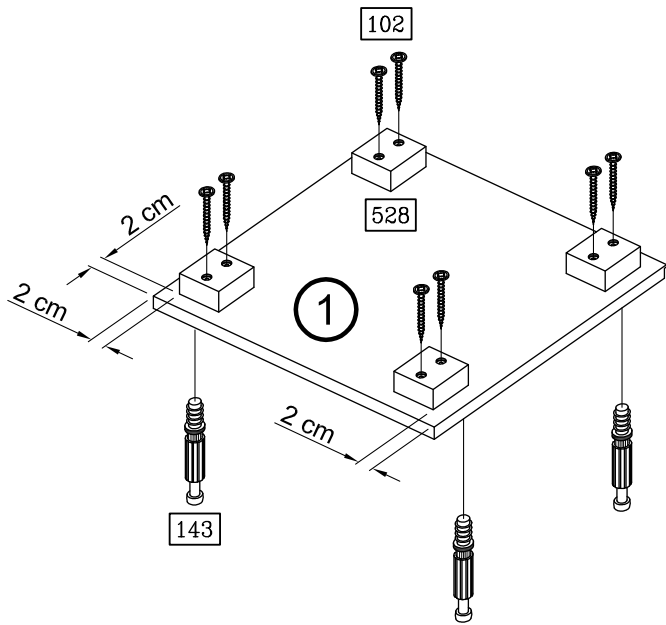

2

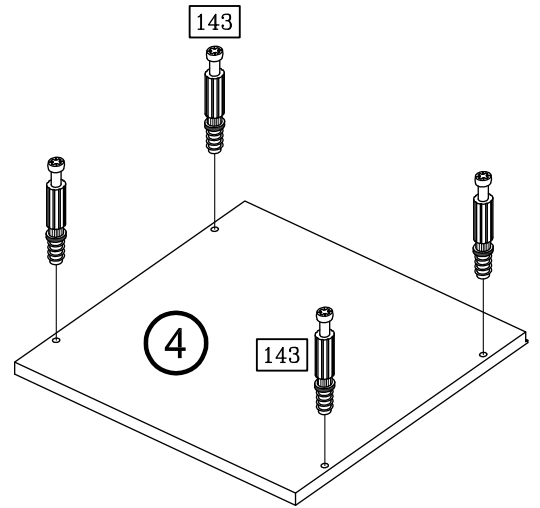

3

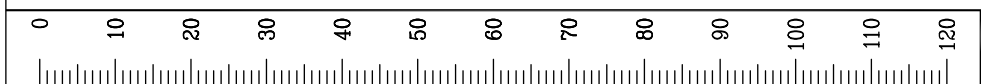
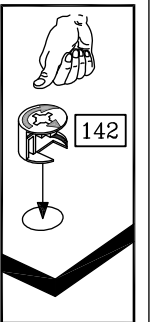
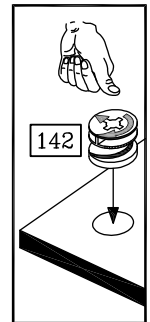
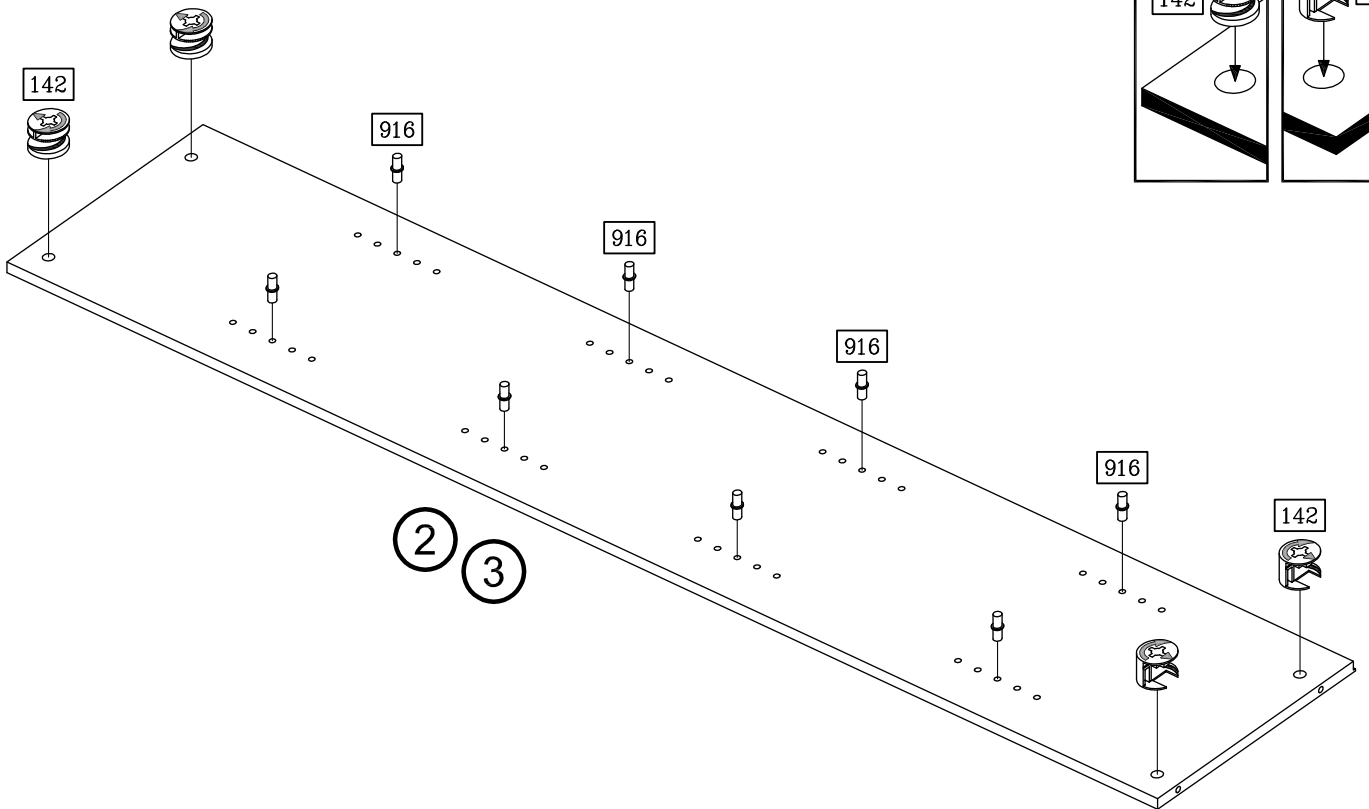

3260-1211

2/4

4

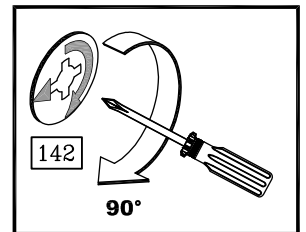
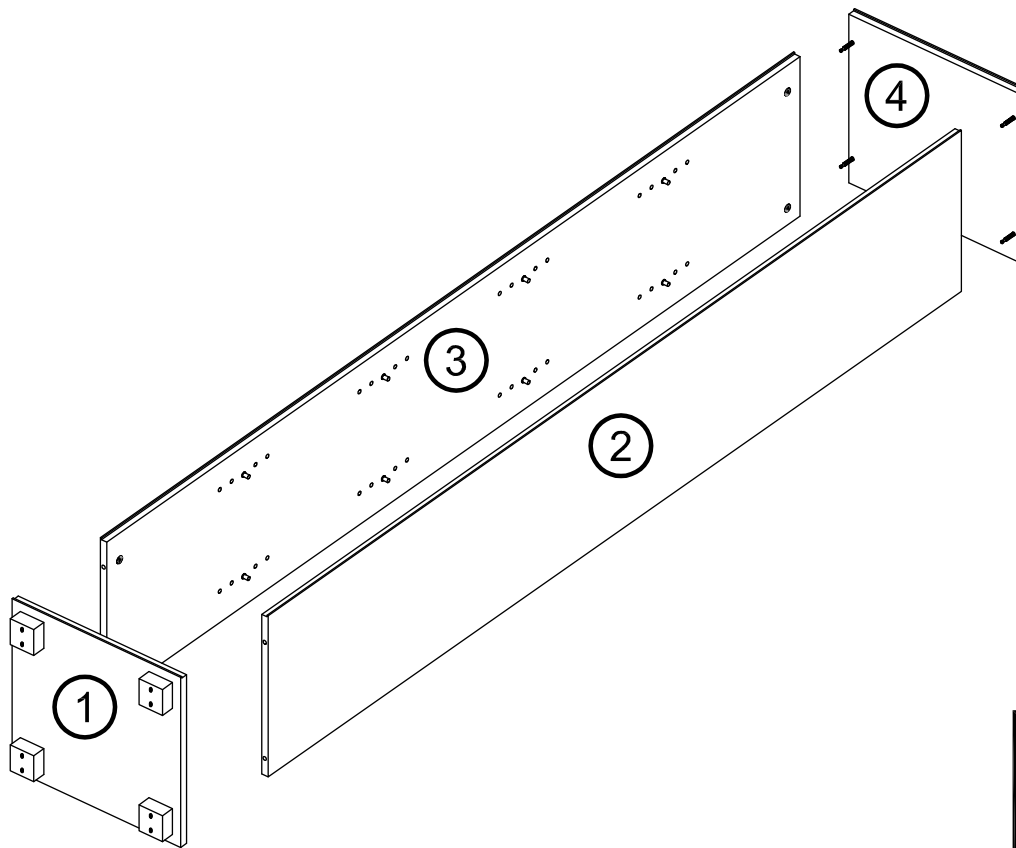

5

