

ORIENT 12
1200

F

230405

D

MONTAGEANLEITUNG
BEDIENUNGSANLEITUNG

NL

HANDLEIDING VOOR DE MONTAGE
GEBRUIKSAANWIJZING

TR

MONTAJ TALIMATI
KULLANIM KLAVUZU

RO

INSTRUCȚIUNI DE INSTALARE
INSTRUCȚIUNI DE UTILIZARE

FR

NOTICE DE MONTAGE
MANUEL INSTRUCTIONS

HU

KÖZGYŰLÉS UTASÍTÁSOK
KEZELÉSI UTASÍTÁS

SI

NAVODILA ZA MONTAŽO
NAVODILA ZA UPORABO

ES

INSTRUCCIONES DE MONTAJE
MANUAL DEL USUARIO

GB

ASSEMBLY INSTRUCTIONS
INSTRUCTION MANUAL

PL

INSTRUKCJA MONTAŻU
INSTRUKCJA OBSŁUGI

RU

ИНСТРУКЦИЯ ПО МОНТАЖУ
ИНСТРУКЦИЯ ПО ЭКСПЛУАТАЦИИ

IT

ISTRUZIONI DI MONTAGGIO
MANUALE DI ISTRUZIONI

SK

MONTÁŽNY NÁVOD
NÁVOD NA POUŽITIE

CZ







MONTÁŽNÍ NÁVOD
NÁVOD K POUŽITÍ

PT

INSTRUÇÕES DE MONTAGEM
MANUAL DO USUÁRIO

HR

UPUTE ZA MONTAŽU
UPUTE ZA UPOTREBU

X H-150	y H-180	q M6*25	i L-4	[mm]
				
X₁ 	X₁ 	X16	X1	
X2	X2	X16	X1	

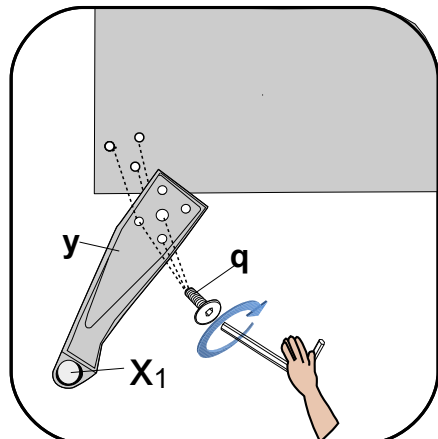
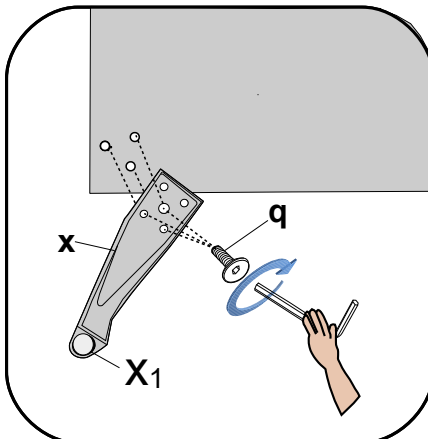
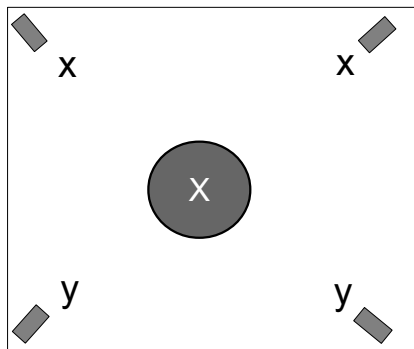
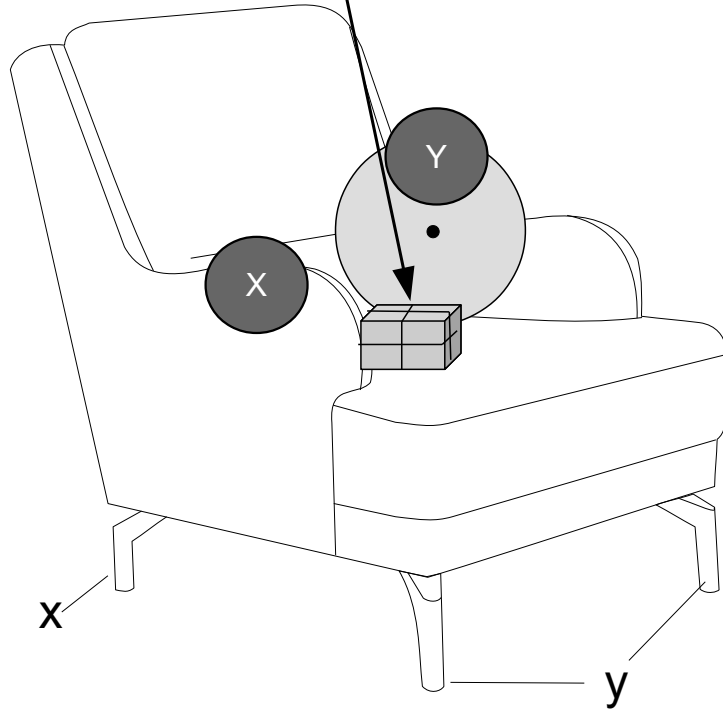





Service · Dienstverlening · Servis · Servis · Сервисная служба · Serviciu · Services · Servizio
 ·Servisný list · Szolgáltatás · Servisní list

Name · Naam · Nazwa · Ísim · Название · Nume · Nome · Názov · Názov ·
 Název · Neve

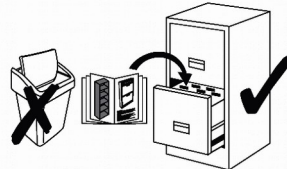
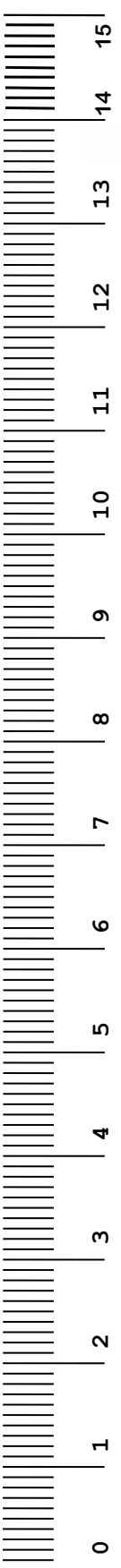
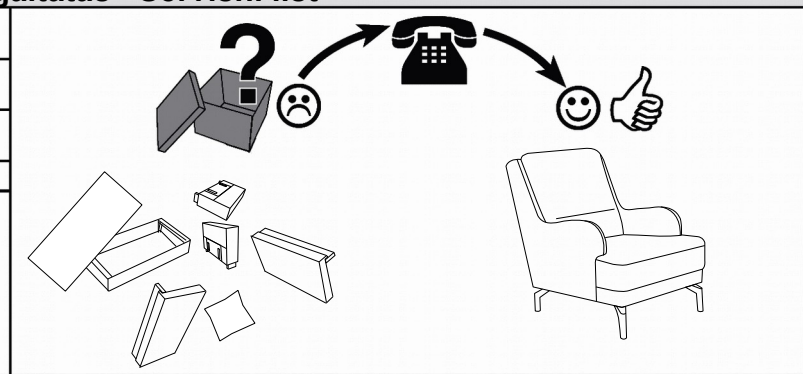
ORIENT 12

Typ · Type · Tip · Тип · Tipo · Típus

X H-150  X ₁	y H-180  x ₁	q M6*25 	i L-4 [mm] 
--	--	---	---

