

## Skien

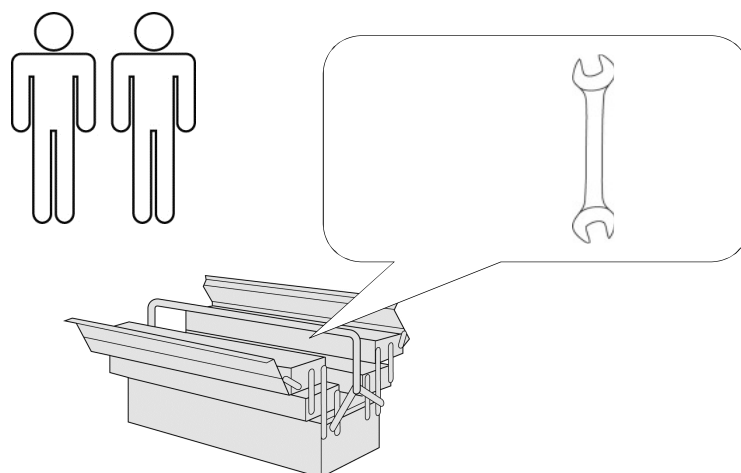

- |                                  |                                       |
|----------------------------------|---------------------------------------|
| <b>D</b> Montageanleitung        | <b>GB</b> Assembly instructions       |
| <b>FR</b> Notice de montage      | <b>NL</b> Handleiding voor de montage |
| <b>CZ</b> Montážní návod         | <b>IT</b> Istruzioni di montaggio     |
| <b>RO</b> Instrucțiuni de montaj | <b>RU</b> инструкция по сборке        |
| <b>PL</b> Instrukcja montażu     | <b>SK</b> Návod na montáž             |
| <b>HU</b> Szerelési útmutató     | <b>TR</b> Montaj talimatı             |

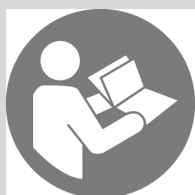



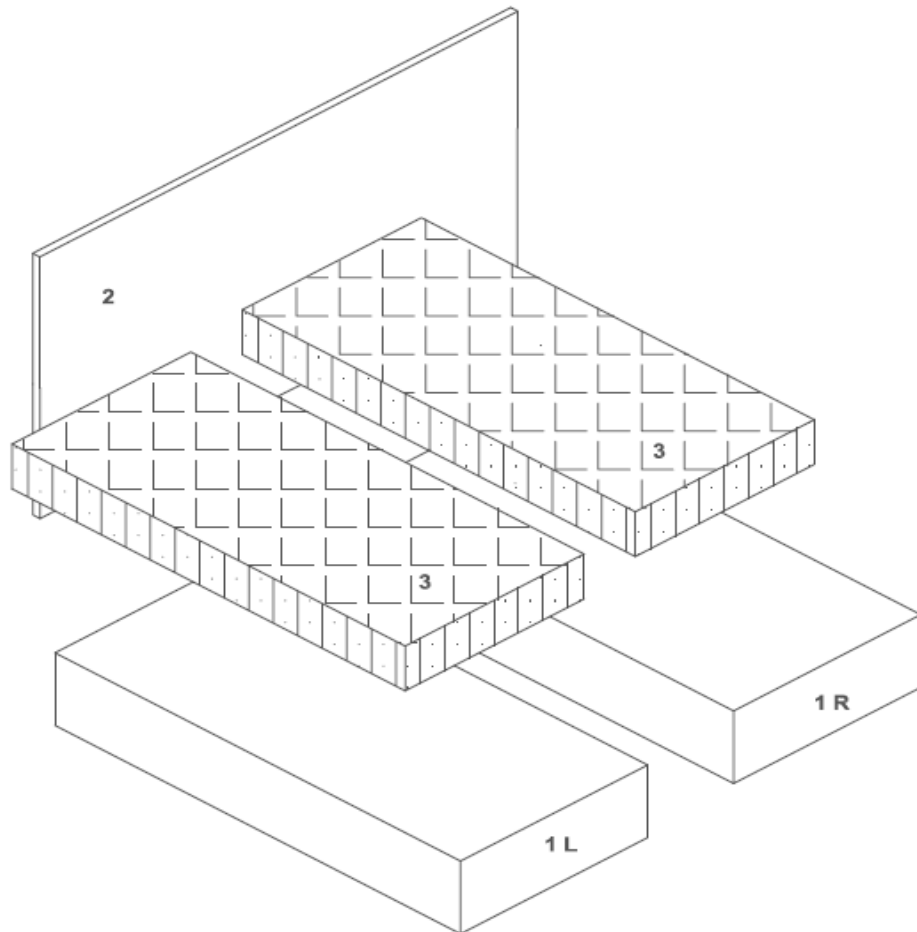

0  
10  
20  
30  
40  
50  
60  
70  
80  
90  
100  
110  
120  
130  
140  
150  
160  
170  
180  
190  
200

<b>Service • Assistenza • Dienstverlening • Serwis</b> <b>Servis • Szerviz • Сервисная служба</b>	
Name • Nom • Nome • Naam Nazwa • Jméno • Názov • Név Denumire • Ísim • Название	<b>Skien DB</b>
Nr. • No. • N° • Номер • Č • Sz	<b>SH50</b>
Typ • Type • Tip • Típus • Tipo Тип	<b>BS K</b>

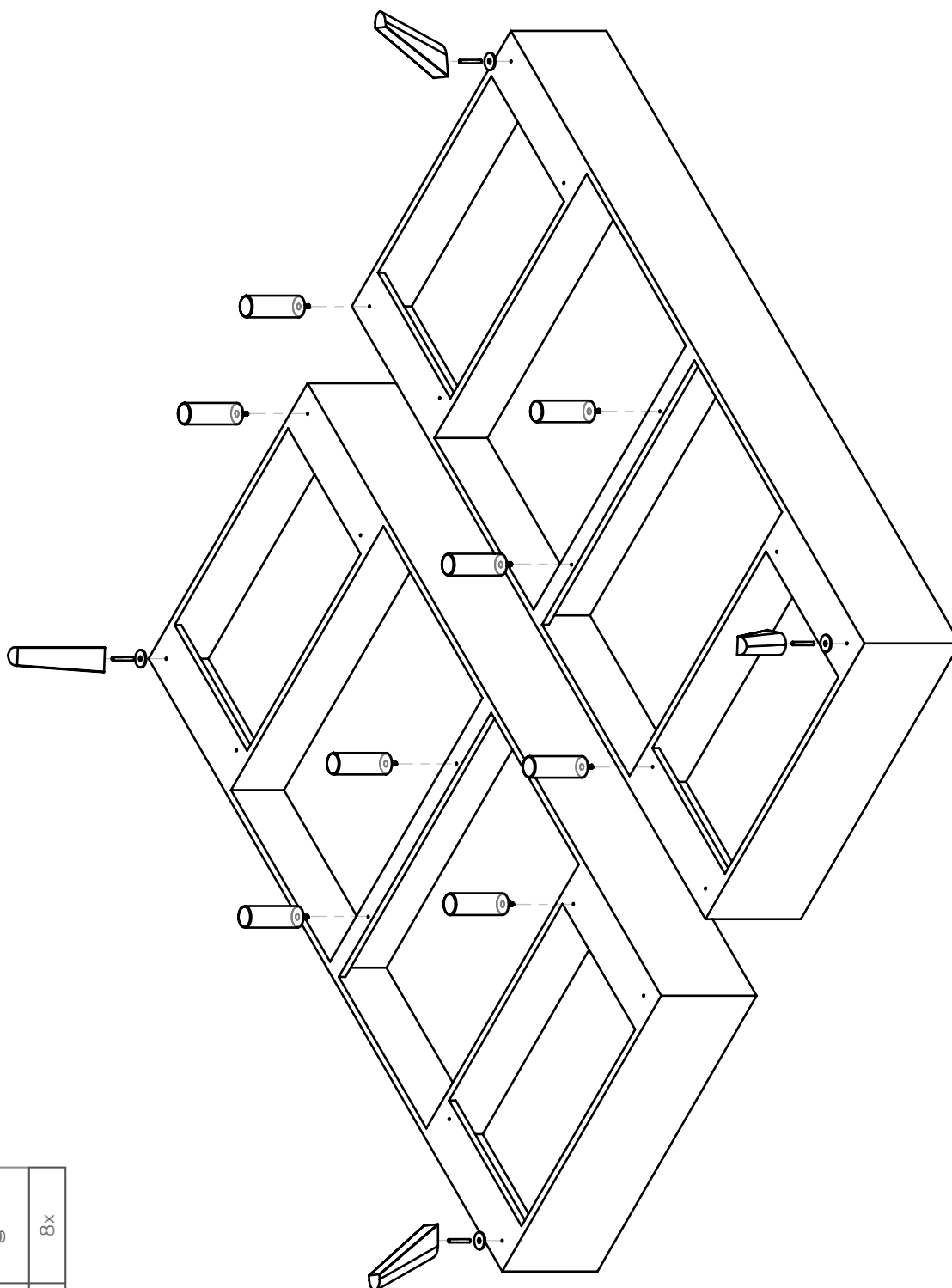

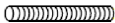

A	B	C	D	E	F
4x	4x 8x45	12x 8x40	8x	8x 8x60	8x M8

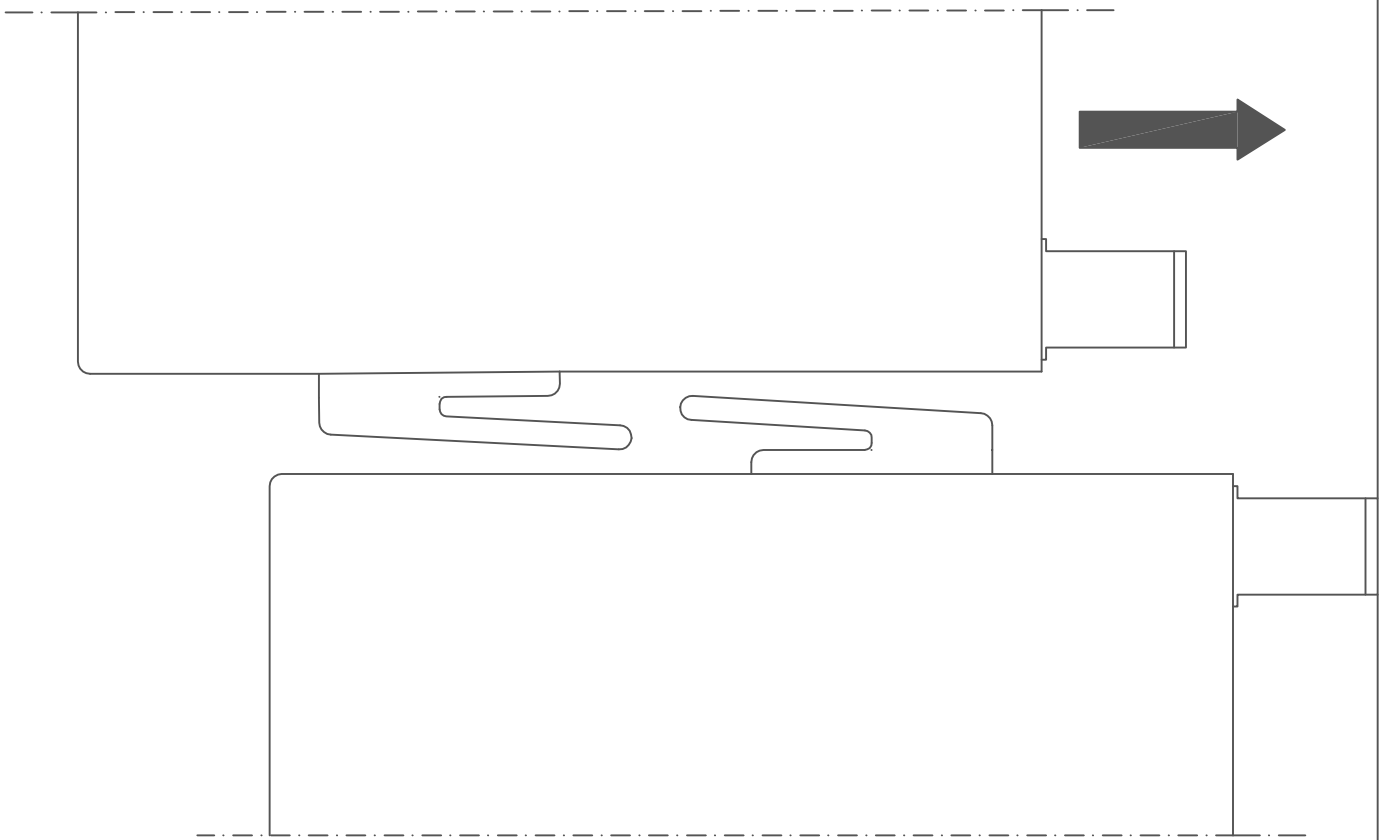

A		4x
B		4x 8x45
C		4x 8x40
D		8x

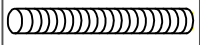

<p>E</p>  <p>8x 8x60</p>	<p>C</p>  <p>8x 8x40</p>	<p>F</p>  <p>8x M8</p>	<p>Achtung! Schrauben nicht überdrehen          FR Attention! Ne serrez pas trop          CZ Dávej Pozor! Nepřetahujte          RO Ai Grija! Nu strângeți          PL Uwaga! Nie dokręcać zbyt mocno          HU Vigyázz! Ne húzza túl</p> <p>GB Watch Out! Do not over tighten          NL Let Op! Niet te vast          IT Attento! Non stringere          RU Осторожно! Не затягивайте          SK Dávaj Pozor! Nepretahujte          TR Dikkat! Üzerinde sıkmayın</p>
---	---	---	---

