

Mandy chair

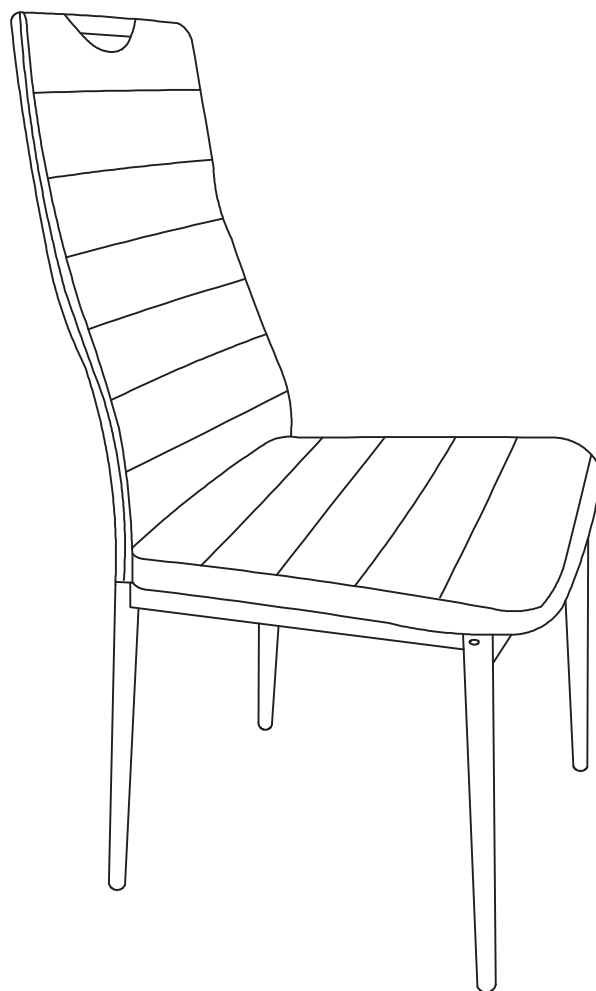

(D) Montageanleitung

(FR) Notice de montage

(NL) Handleiding voor de montage

(CZ) Montážní návod

(HU) Szerelési útmutató

(TR) Montaj talimatı

(GB) Assembly instructions

(IT) Istruzioni di montaggio

(PL) Instrukcja montażu

(SK) Návod na montáž

(RO) Instrucțiuni de montaj

(RU) Инструкция по монтажу

**Service • Assistenza • Dienstverlening • Serwis
Servis • Szerviz • Сервисная служба**

Name • Nom • Nome • Naam •
Nazwa • Jméno • Názov • Név •
Denimire • Ísim • Название

Nr. • No. • N° • Номер • Č • Sz

Tур • Type • Tír • Típus • Tíro •
Тип

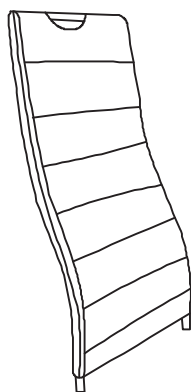
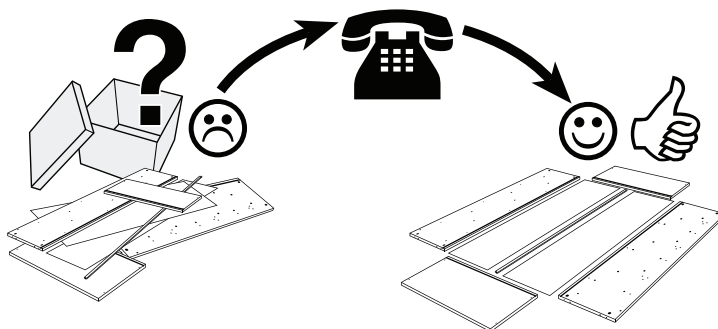
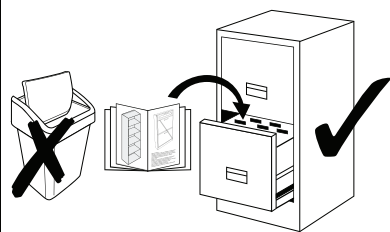

1 1x

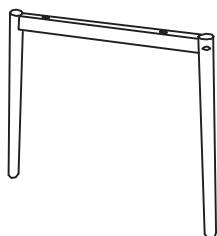

2 1x

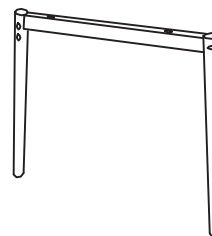

3 1x

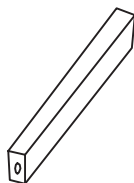

4 1x



5 1x

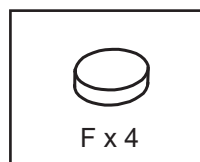
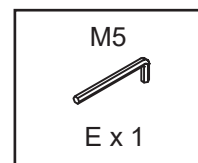
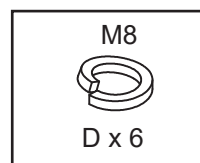
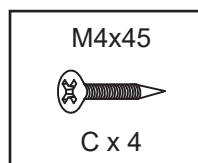
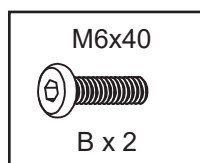
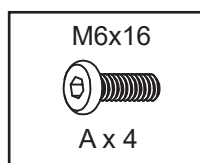

1

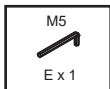
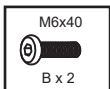
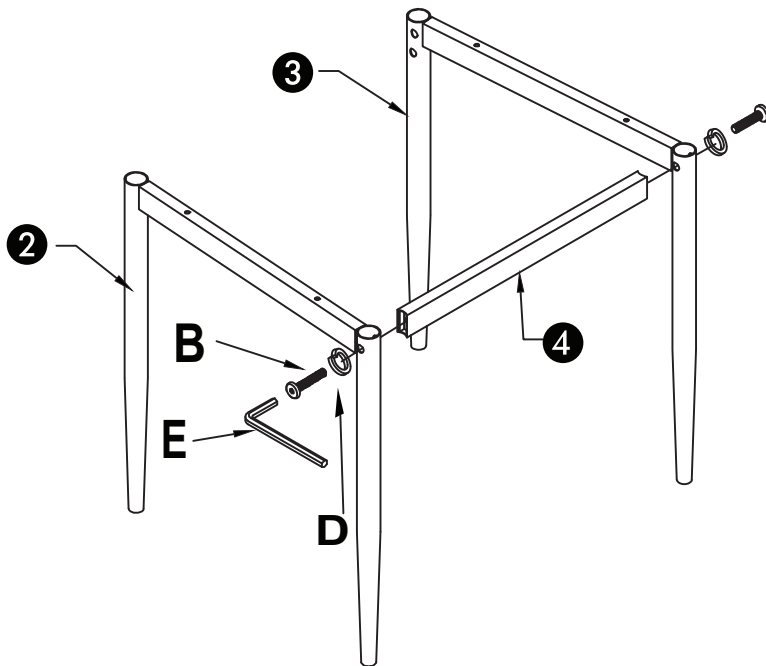

2

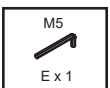
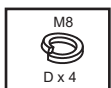
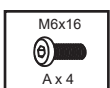
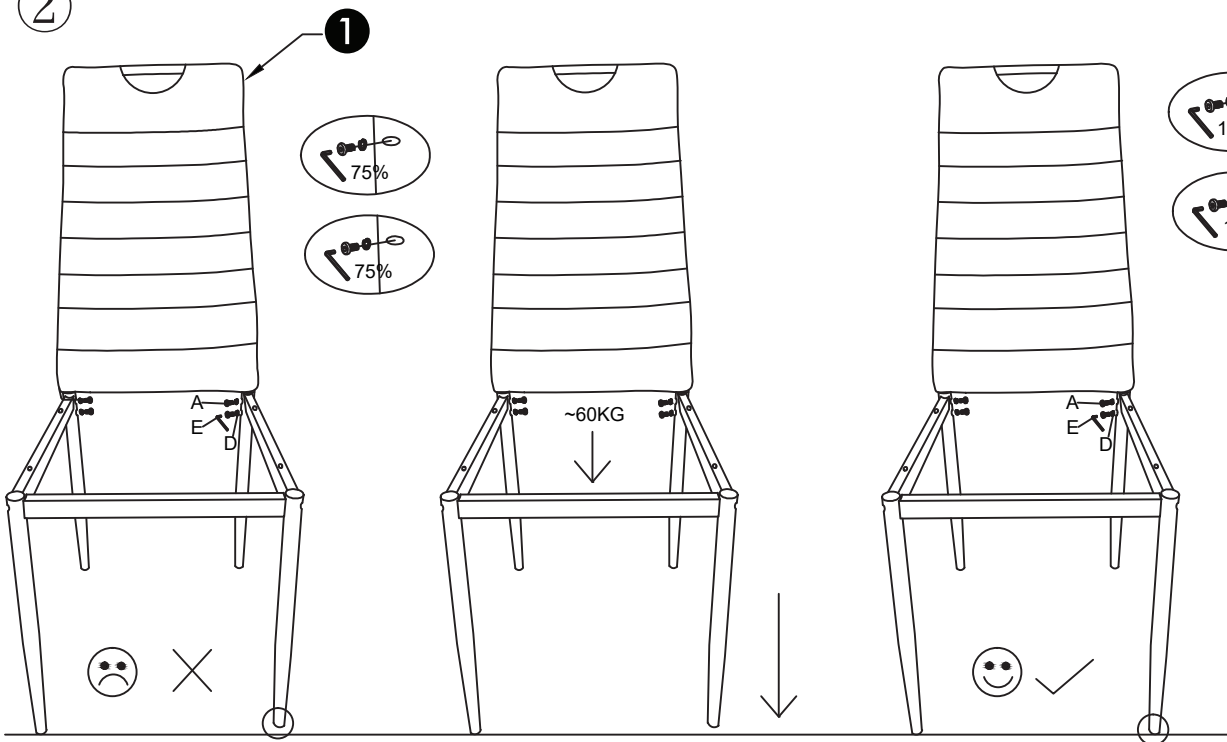

3

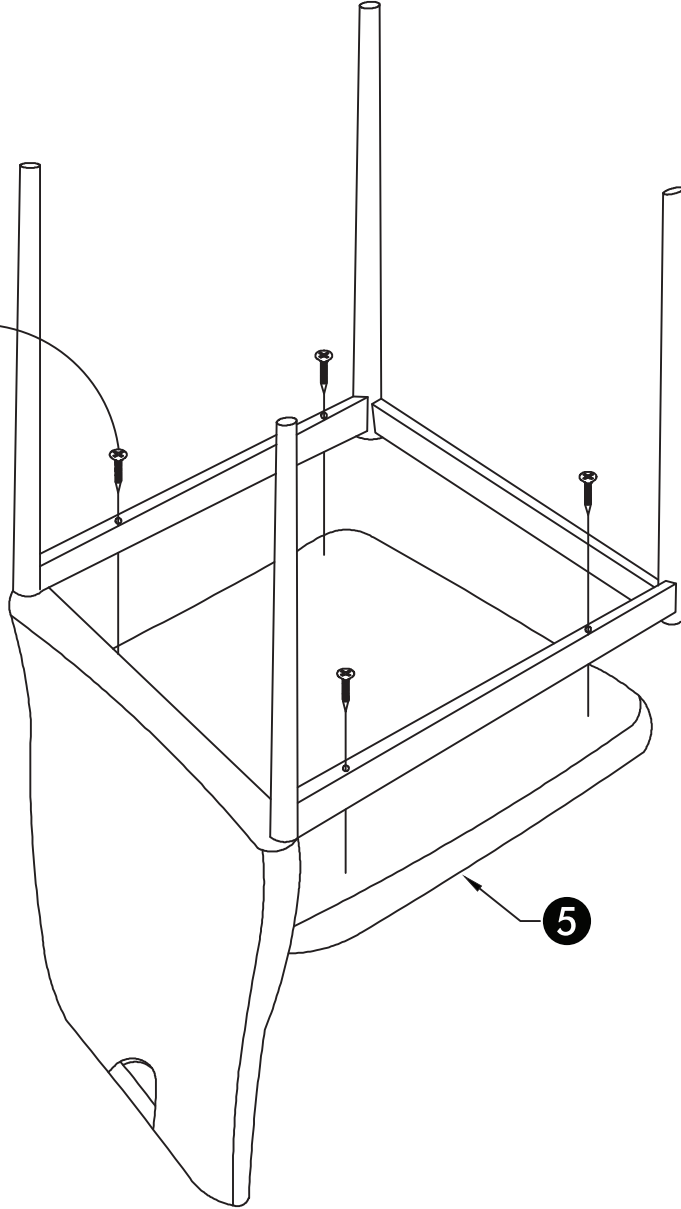
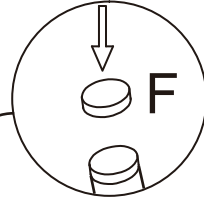
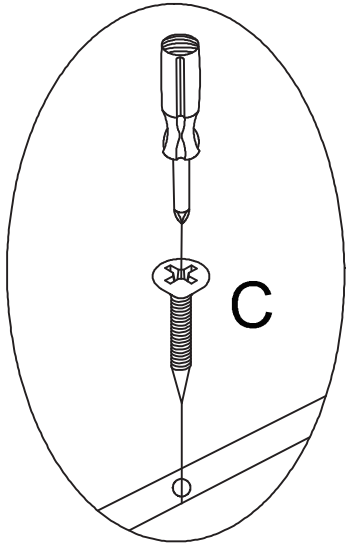

5

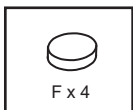
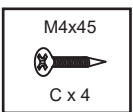



max. 120kg

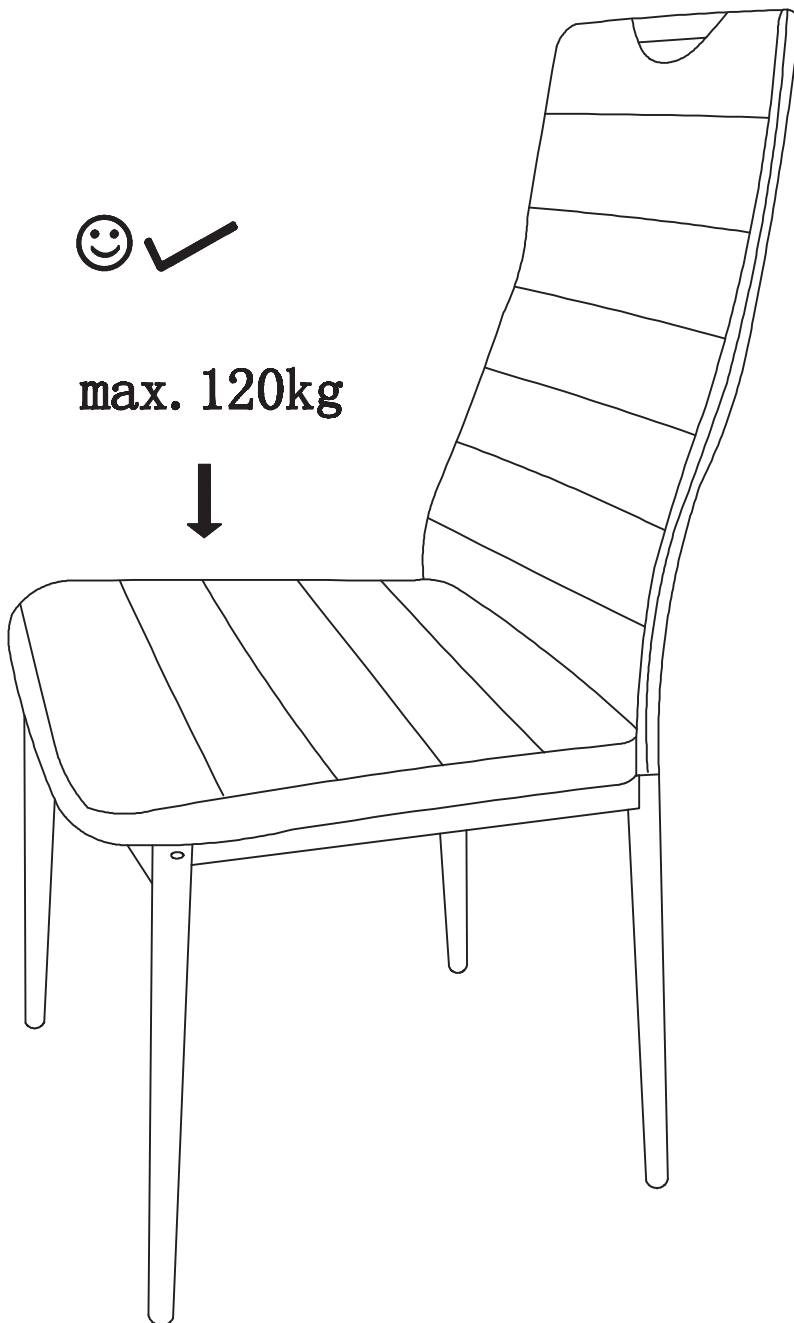

Silvi table

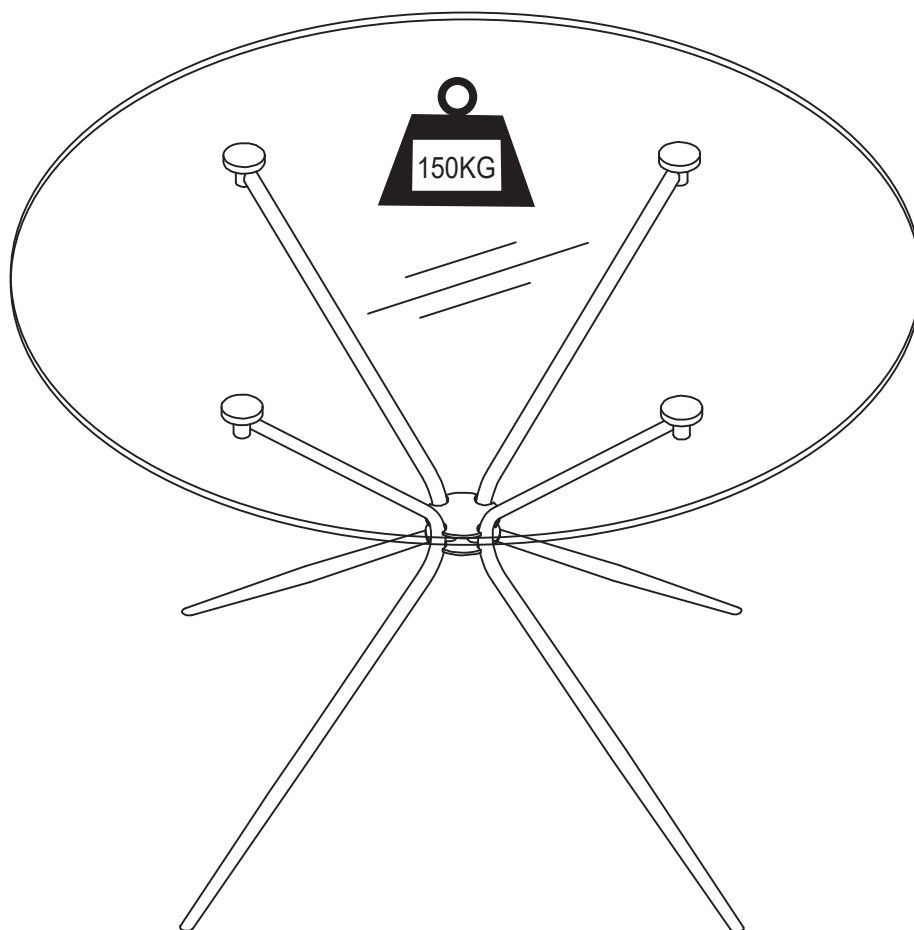

(D) Montageanleitung

(FR) Notice de montage

(NL) Handleiding voor de montage

(CZ) Montážní návod

(HU) Szerelési útmutató

(TR) Montaj talimatı

(GB) Assembly instructions

(IT) Istruzioni di montaggio

(PL) Instrukcja montażu

(SK) Návod na montáž

(RO) Instrucțiuni de montaj

(RU) ИНСТРУКЦИЯ ПО МОНТАЖУ

**Service • Assistenza • Dienstverlening • Serwis
Servis • Szerviz • Сервисная служба**

Name • Nom • Nome • Naam •
Nazwa • Jméno • Názov • Név •
Denumire • İsim • Название

Nr. • No. • N° • Номер • Č. • Sz

Тур • Туре • Тир • Típus • Тиро •
Тип

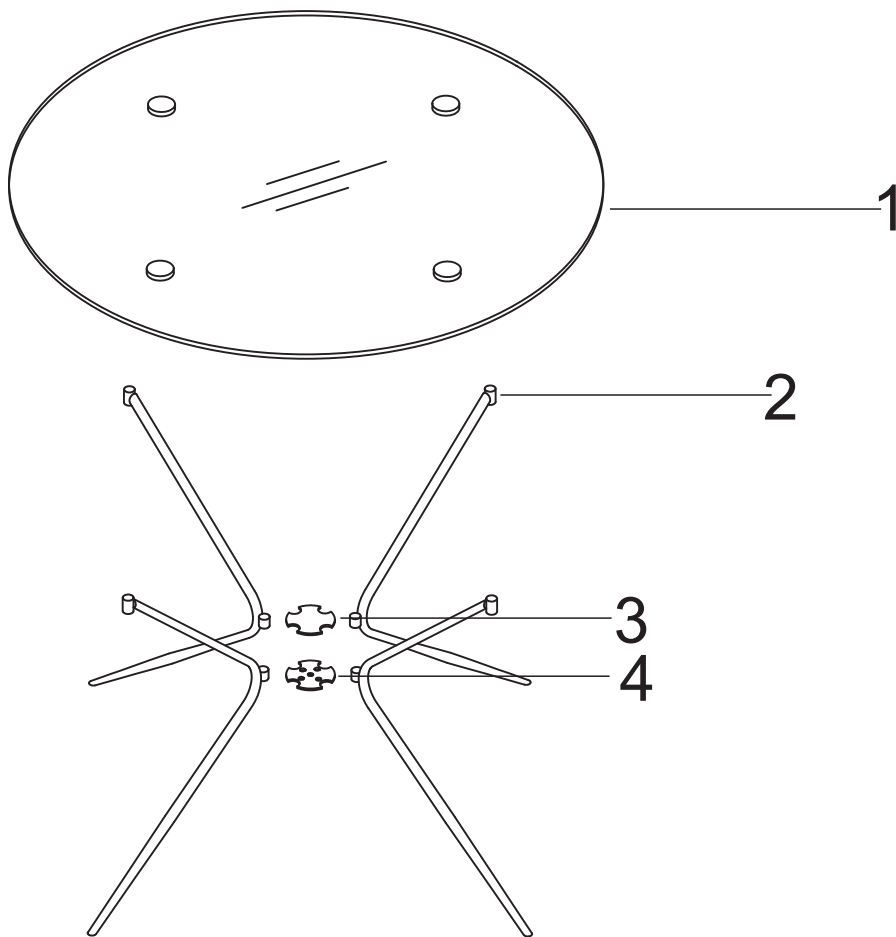
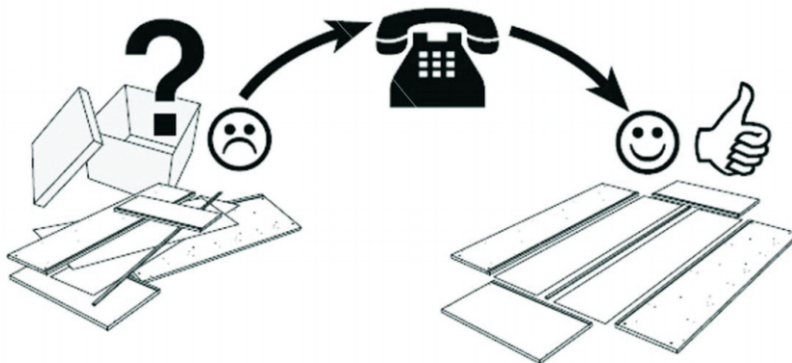
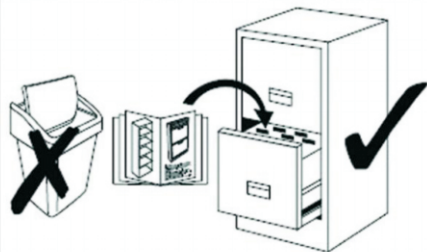

M8X20mm
A*8



M6X25mm
B*1



M8
C*4



M8
D*8



E*1



F*4

1

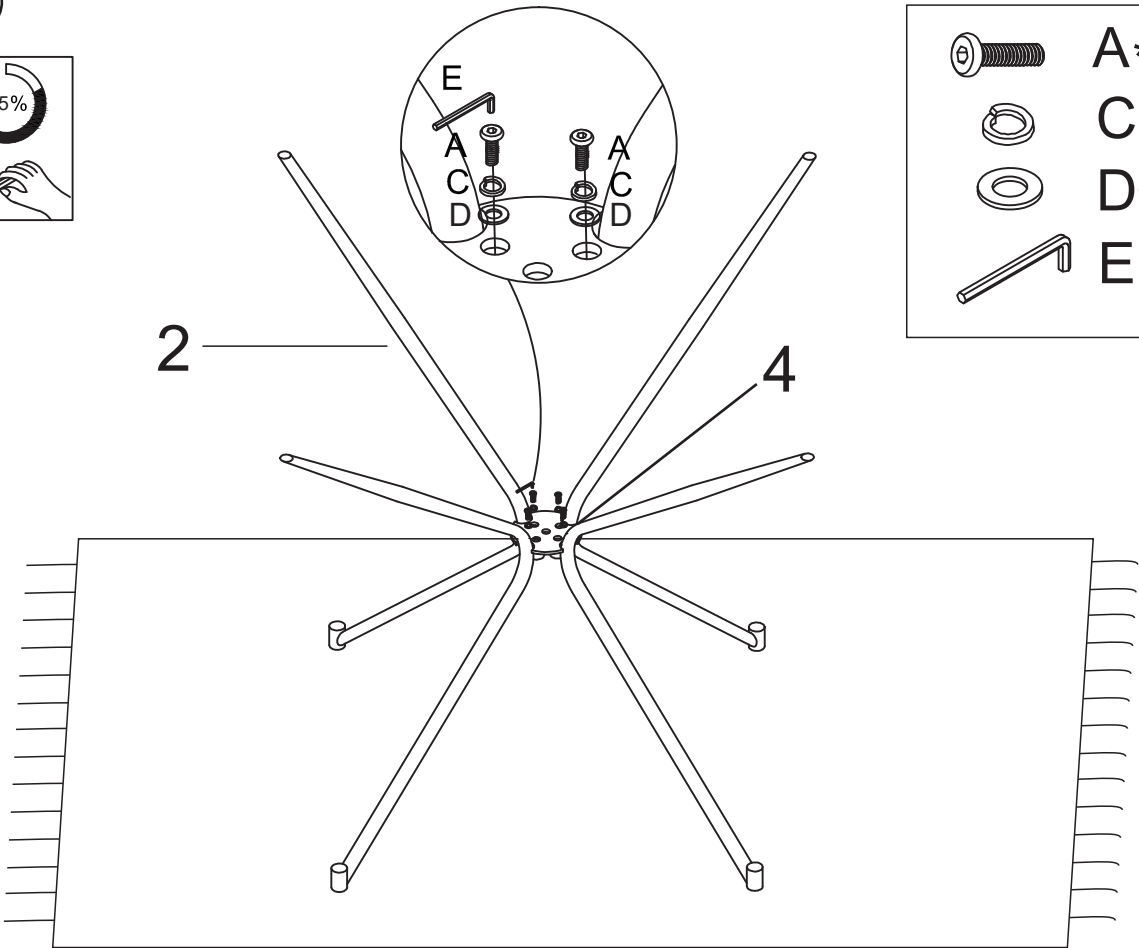
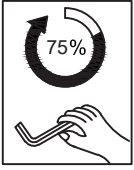

- | | |
|--|-----|
| | A*4 |
| | C*4 |
| | D*4 |
| | E*1 |

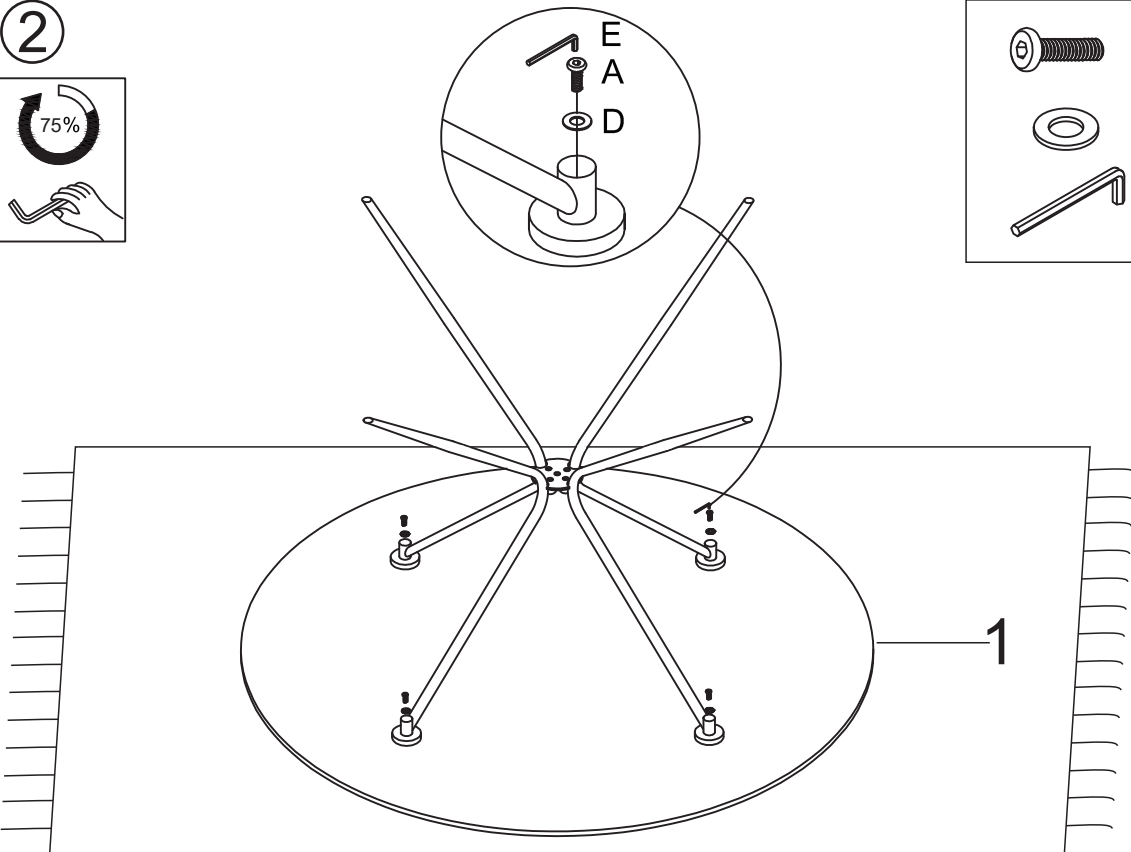
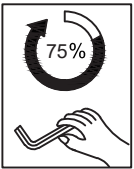

2

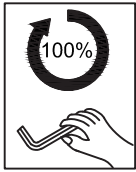

- | | |
|--|-----|
| | A*4 |
| | D*4 |
| | E*1 |

3



	B*1
	E*1
	F*4

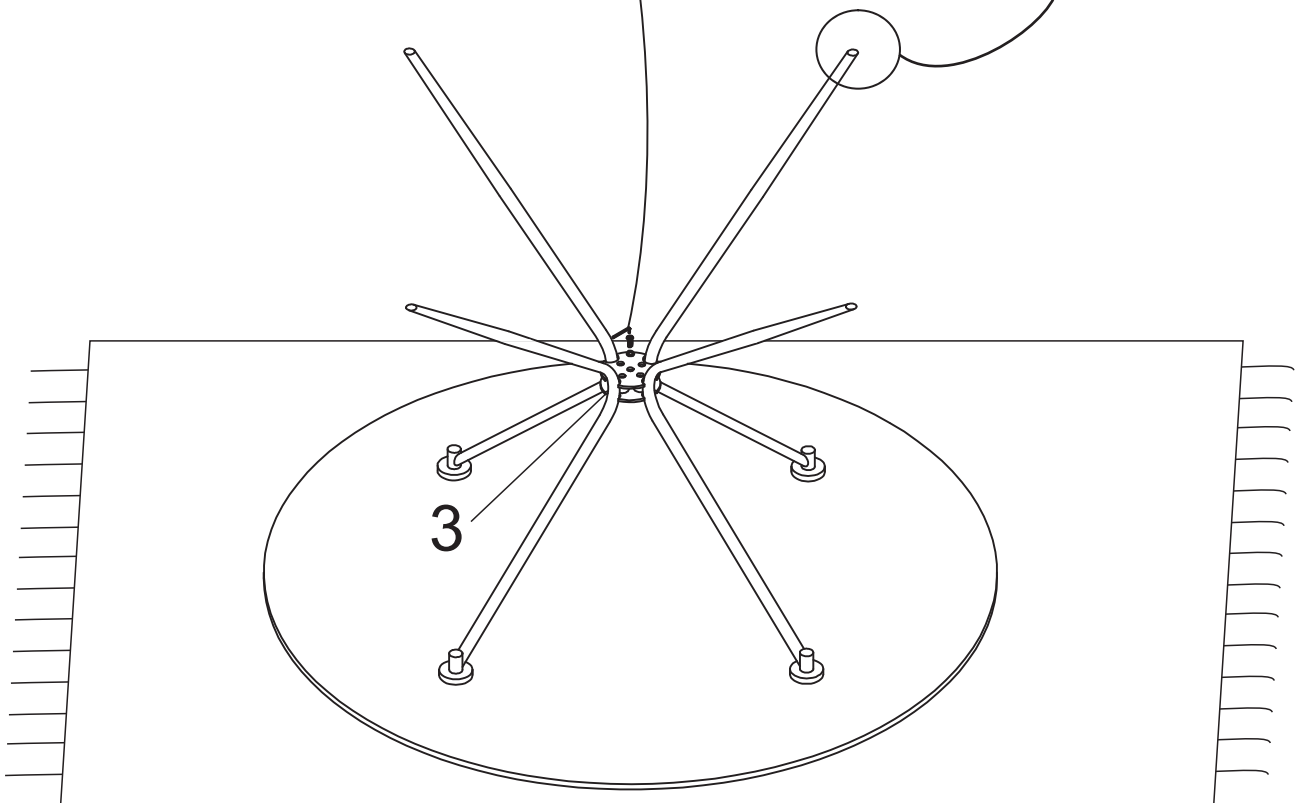
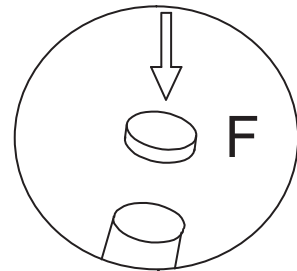
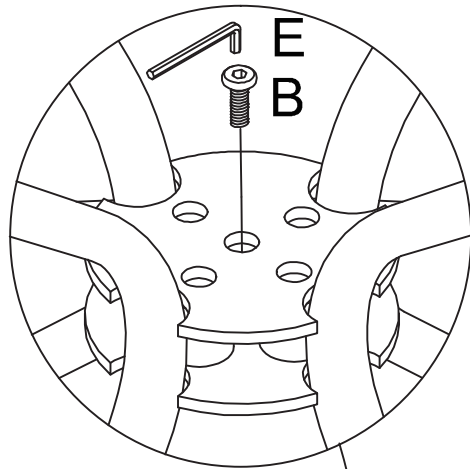

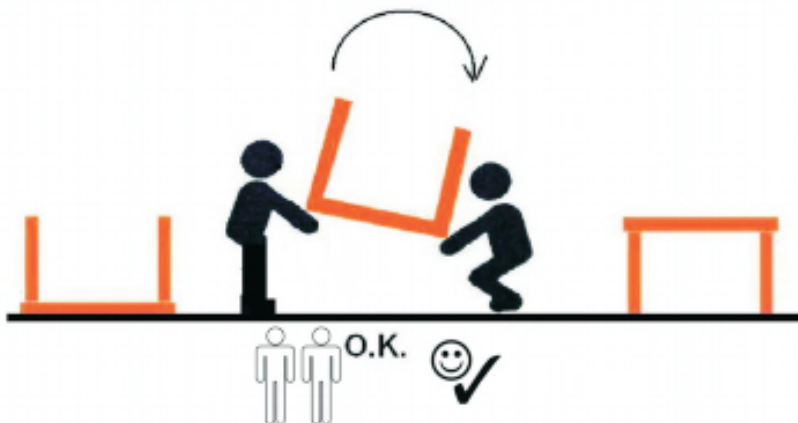
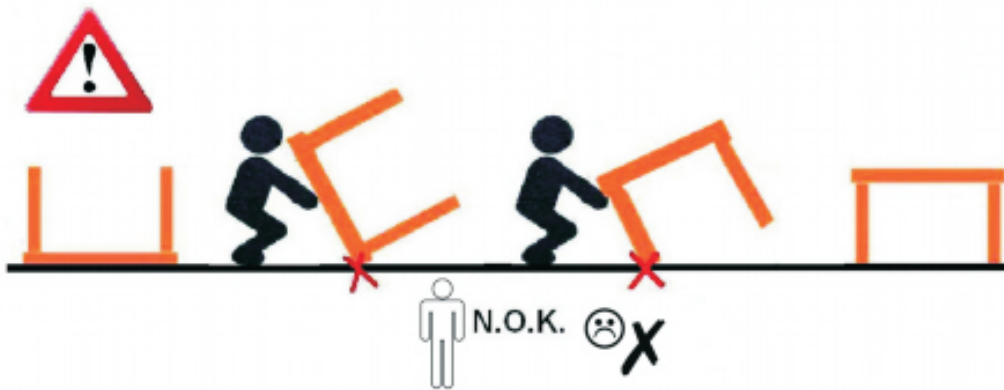
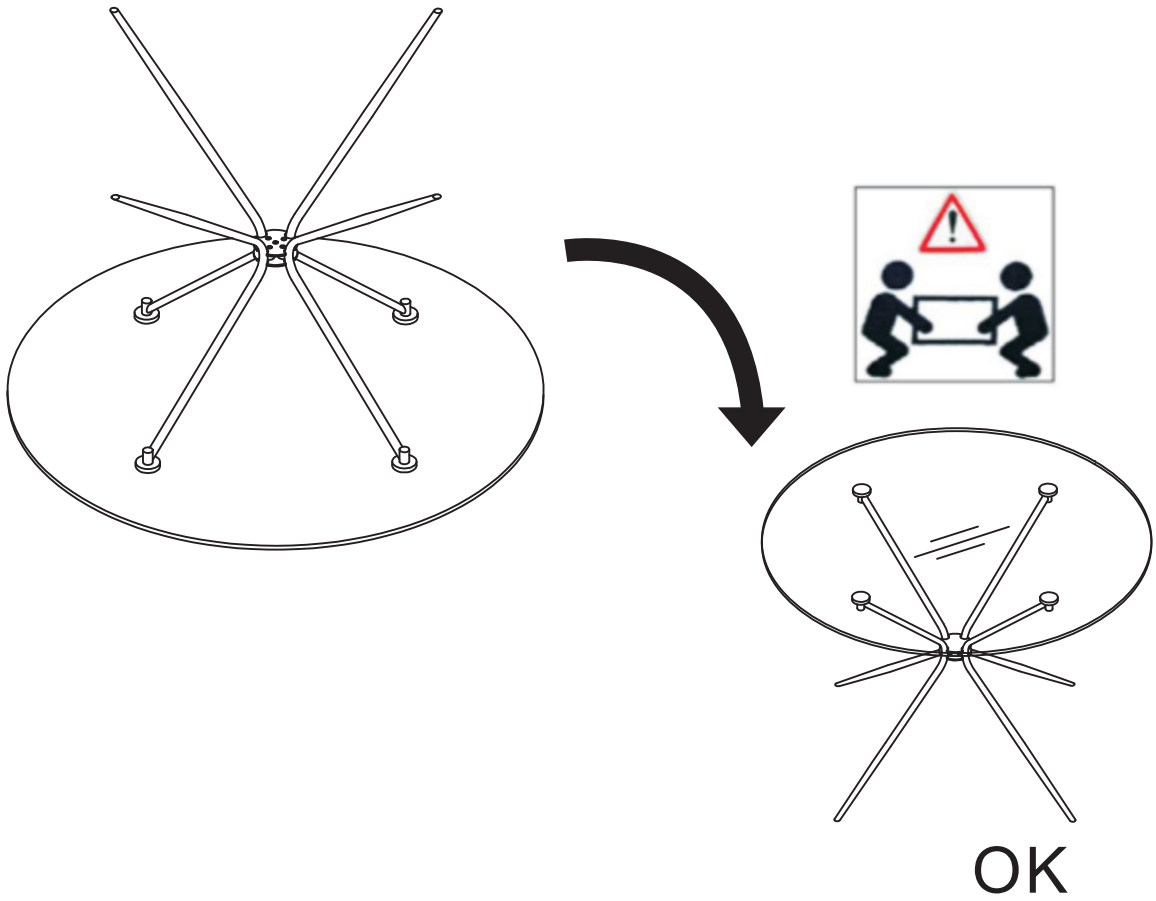

5/5