

## Oregon

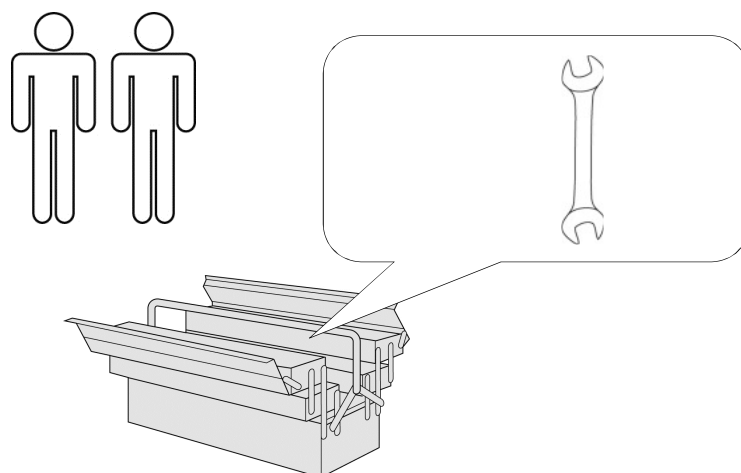







- |                                  |                                       |
|----------------------------------|---------------------------------------|
| <b>D</b> Montageanleitung        | <b>GB</b> Assembly instructions       |
| <b>FR</b> Notice de montage      | <b>NL</b> Handleiding voor de montage |
| <b>CZ</b> Montážní návod         | <b>IT</b> Istruzioni di montaggio     |
| <b>RO</b> Instrucțiuni de montaj | <b>RU</b> инструкция по сборке        |
| <b>PL</b> Instrukcja montażu     | <b>SK</b> Návod na montáž             |
| <b>HU</b> Szerelési útmutató     | <b>TR</b> Montaj talimatı             |

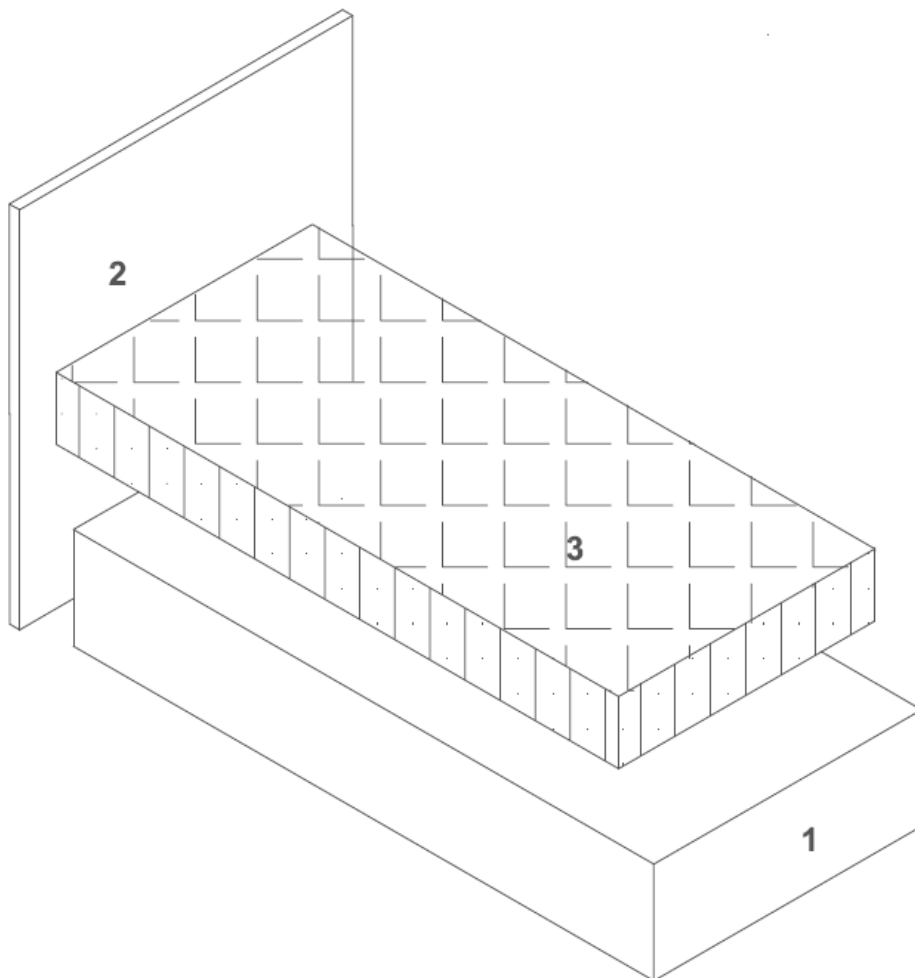
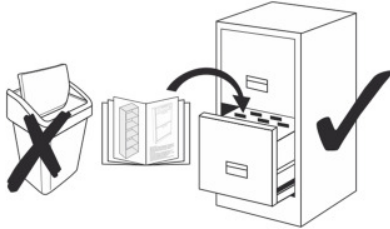
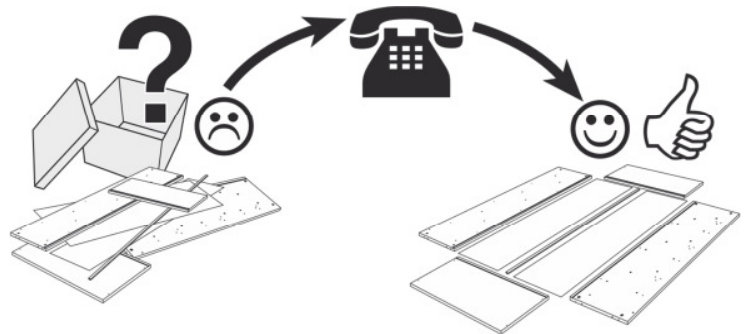

## Service • Assistenza • Dienstverlening • Serwis Servis • Szerviz • Сервисная служба

Name • Nom • Nome • Naam Nazwa • Jméno • Názov • Név Denumire • Ísim • Название	<b>Orgon EB</b>
Nr. • No. • N° • Номер • Č • Sz	<b>SH50</b>
Typ • Type • Tip • Típus • Tipo Тип	<b>BS G</b>







A	B	C	D	E	F
					
4x	8x 8x40	2x	2x 8x50	4x 8x60	4x M8

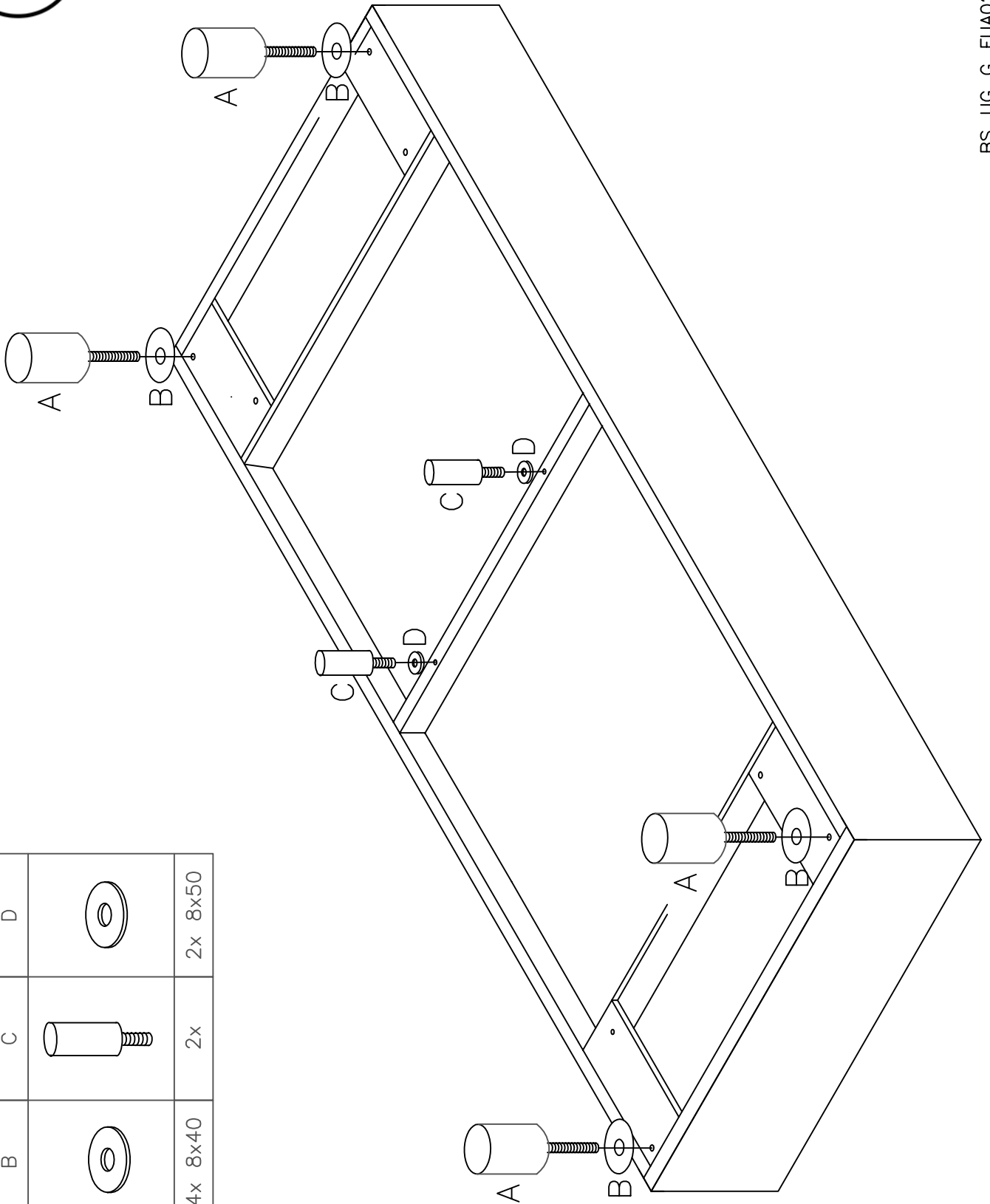

A		4x	
B		4x 8x40	
C		2x	
D		2x 8x50	

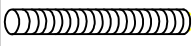



E		4x 8x60	4x 8x40	4x M8	<p>Achtung! Schrauben nicht überdrehen</p> <p>FR Attention! Ne serrez pas trop</p> <p>CZ Dávej Pozor! Nepřetahujte</p> <p>RO Ai Grija! Nu strângeți</p> <p>PL Uwaga! Nie dokręcać zbyt mocno</p> <p>HU Vigyázz! Ne húzza túl</p> <p>GB Watch Out! Do not over tighten</p> <p>NL Let Op! Niet te vast</p> <p>IT Attento! Non stringere</p> <p>RU Осторожно! Не затягивайте</p> <p>SK Dávaj Pozor! Nepretahujte</p> <p>TR Dikkat! Üzerinde sıkmayın</p>
F		4x M8	4x 8x40	4x M8	
B		4x 8x40	4x 8x40	4x M8	
F		4x M8	4x 8x40	4x M8	
B		4x 8x40	4x 8x40	4x M8	

