

Montageanleitung	D	Руководство по монтажу	RUS
Installation Instructions	GB	Instrucțiuni de instalare	RO
Instructions d'installation	F	Návod na montáž	SK
Montagehandleiding	NL	Návod k instalaci	CZ
Istruzioni di montaggio	I	Szerelési útmutató	H
Instrukcja montażu	PL	Kurulum Talimatları	TR

01.2019

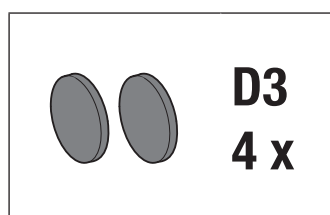
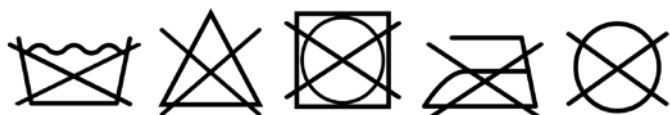
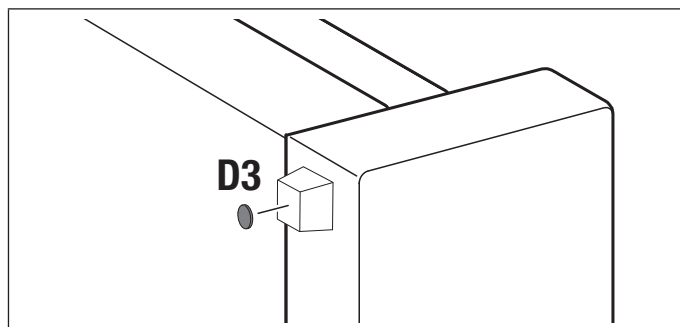
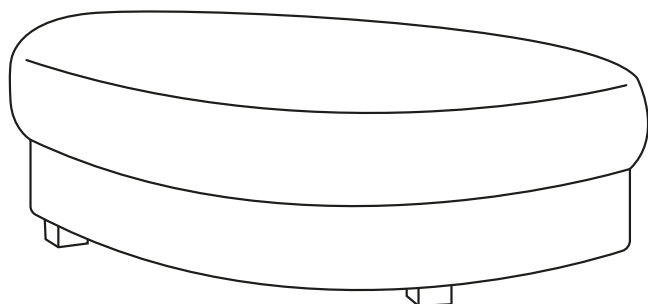

**Service • Assistenza • Dienstverlening • Serwis •
Servis • Szervis • Сервисная служба**

Name • Nom • Nome • Naam •
Nazwa • Jméno • Názov • Nev •
Denumire • Isim • Название

Limoncello

Typ • Type • Tip • Tipus • Tipo •
Тип

Hocker

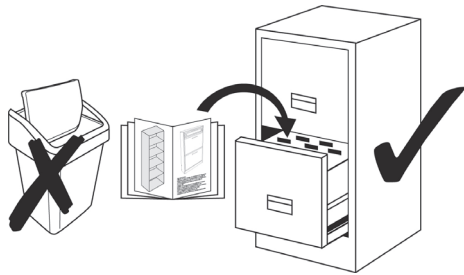
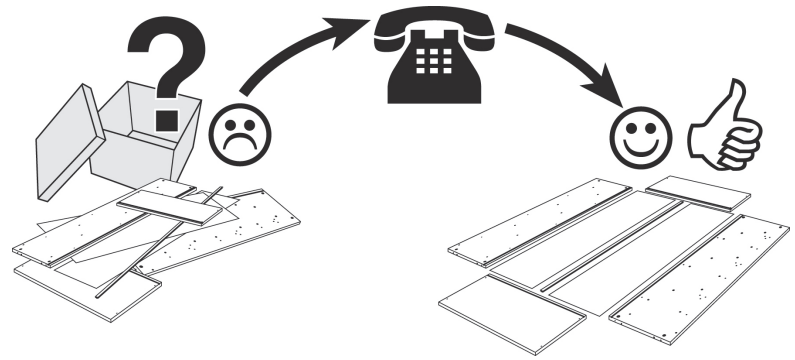
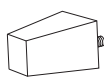
B11
4 x

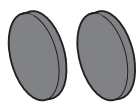

D3
4 x

