

# Selena

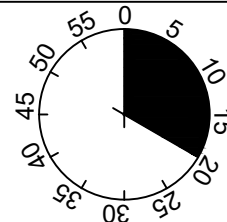
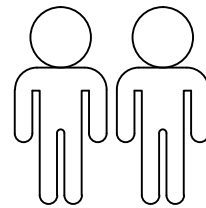
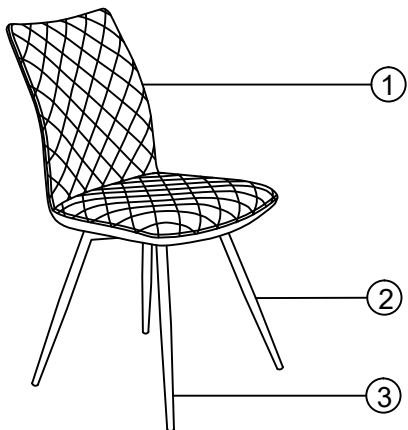

1

2

3

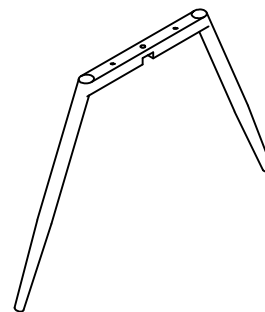
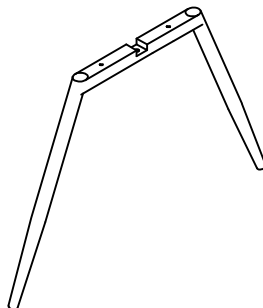
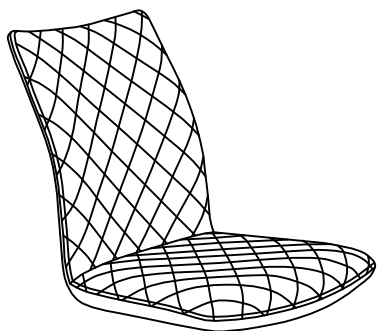

4

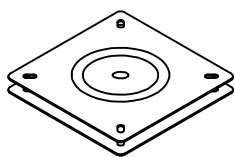

DT 175X175mm

1	1 x
2	1 x
3	1 x
4	1 x

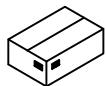





1/1

A	M6X20	B	M6x13	C	M6x30	D	Ø18xØ6x1.5	E	Ø18xØ8x8	F	4MM
6x		4x		2x		8x		2x		1x	
G	T3.0x95x95										
1x											

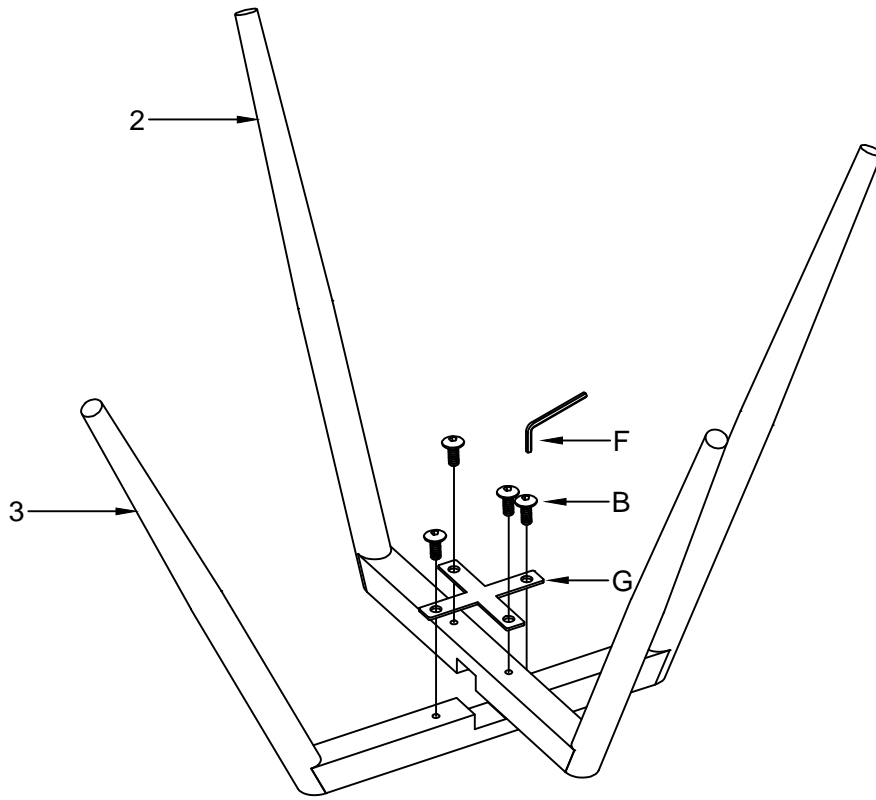
I.



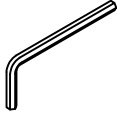
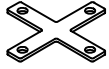

1

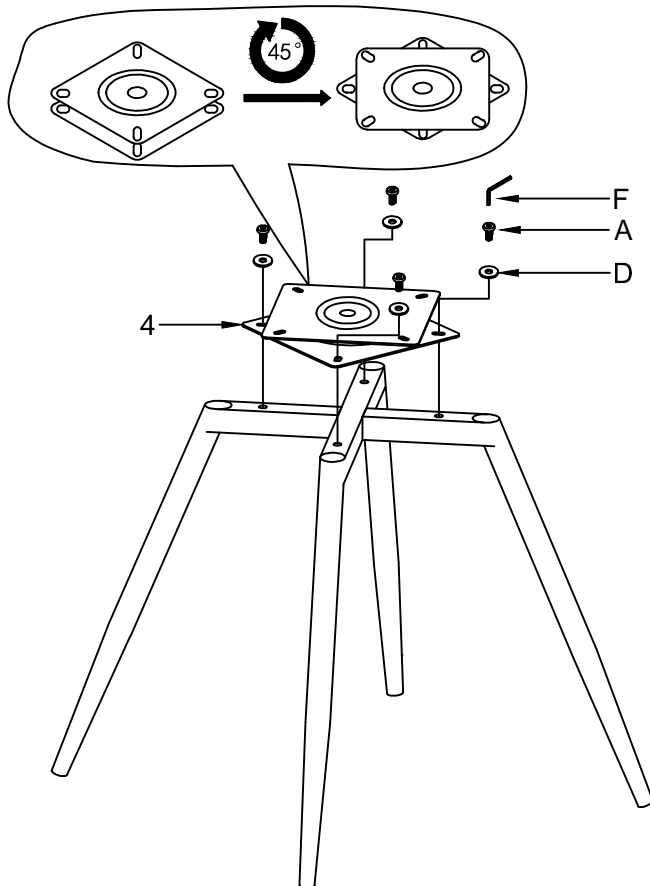

B	M6x13	
		4x
F	4MM	
		1x
G	T3.0x95x95	
		1x
		

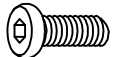
2

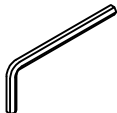





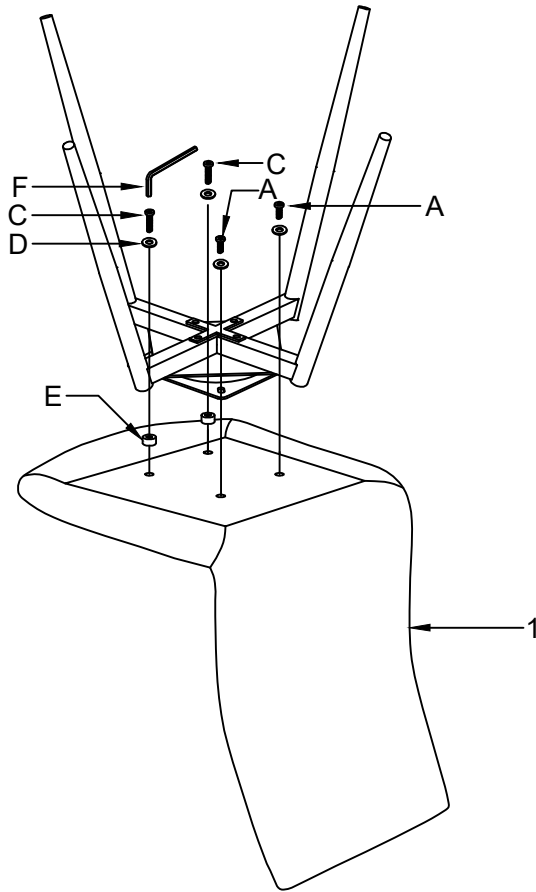

A	M6X20	
		4x
D	Ø18xØ6x1.5	
		4x
F	4MM	
		1x
		

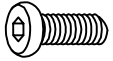
II.

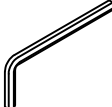

3



A	M6X20		2x
C	M6X30		2x
D	Ø18xØ6x1.5		4x
E	Ø18xØ8x8		2x
F	4MM		1x
			

4

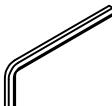

F	4MM		1x
			



LE TRI  
+ FACILE



+



Séparez les éléments avant de trier