

- |                                  |                              |
|----------------------------------|------------------------------|
| (D) Montageanleitung             | (FR) Notice de montage       |
| (NL) Handleiding voor de montage | (CZ) Montážní návod          |
| (HU) Szerelési útmutató          | (TR) Montaj talimatı         |
| (GB) Assembly instructions       | (IT) Istruzioni di montaggio |
| (PL) Instrukcja montażu          | (SK) Návod na montáž         |
| (RO) Instrucțiuni de montaj      | (RU) Инструкция по монтажу   |

Service • Assistenza • Dienstverlening • Serwis  
 Servis • Szerviz • Сервисная служба

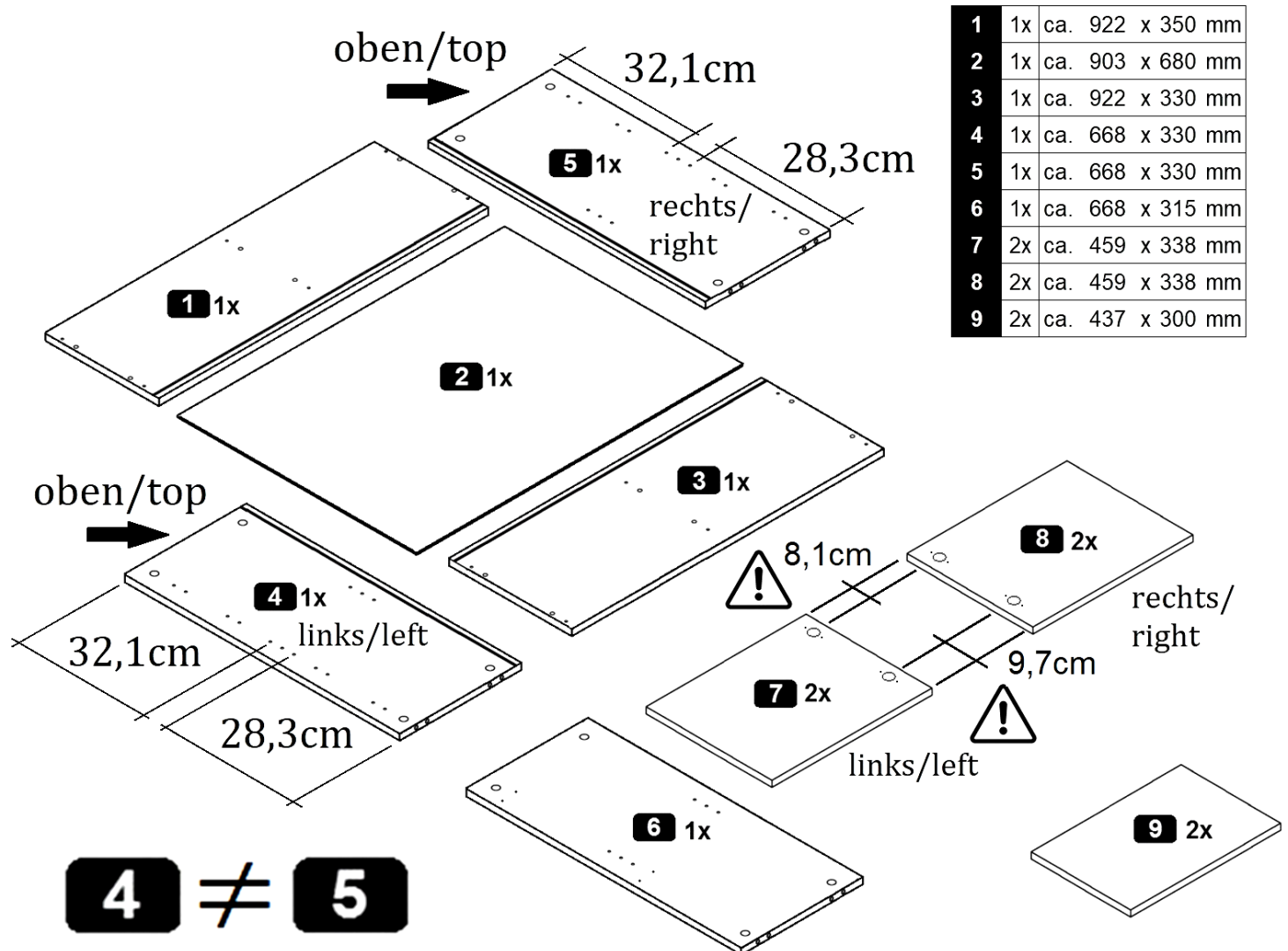

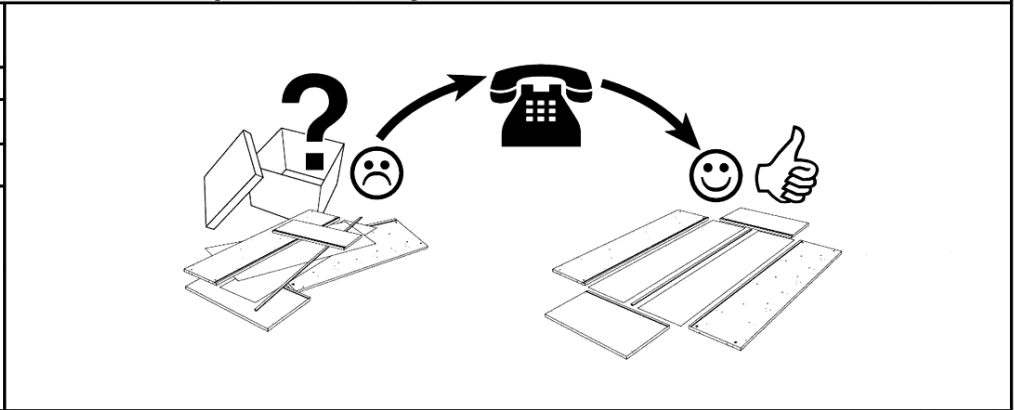

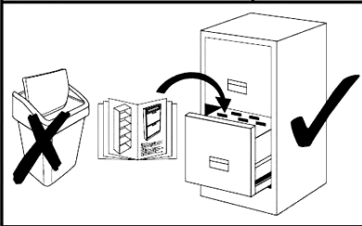





Name • Nom • Nome • Naam • Nazwa • Jméno • Názov • Név • Denumire • İsim • Название	
Nr. • No. • N° • Номер • Č • Sz	
Typ • Type • Тип • Típus • Тиро • Тип	
	



1	1x	ca. 922 x 350 mm
2	1x	ca. 903 x 680 mm
3	1x	ca. 922 x 330 mm
4	1x	ca. 668 x 330 mm
5	1x	ca. 668 x 330 mm
6	1x	ca. 668 x 315 mm
7	2x	ca. 459 x 338 mm
8	2x	ca. 459 x 338 mm
9	2x	ca. 437 x 300 mm



**7 ≠ 8**

<b>A</b> 8,0 x 30 mm  12x	<b>B</b>  12x	<b>C</b>  12x	<b>D</b>  4x	<b>E</b> 3,9 x 9,5 mm  8x	<b>F</b>  5x	<b>G</b> 4,0 x 20 mm  5x
<b>H</b> Ø35 Kr.0  3,5x13 mm 8x	<b>I</b> h=2  8x	<b>J</b>  8x	<b>K</b> 2,7 x 20 mm  6x			

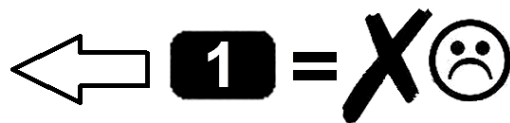
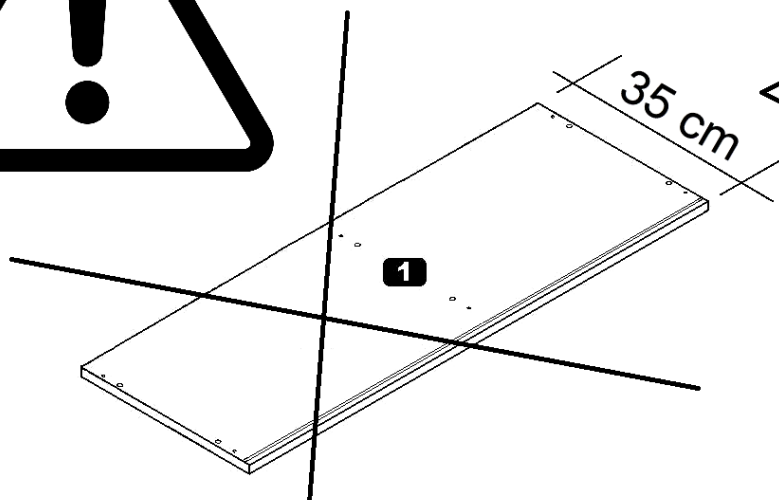
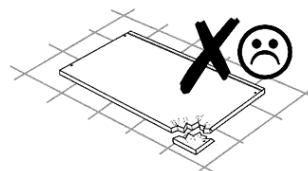
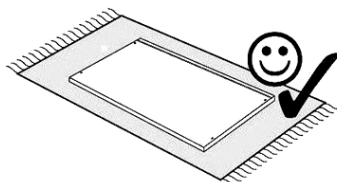



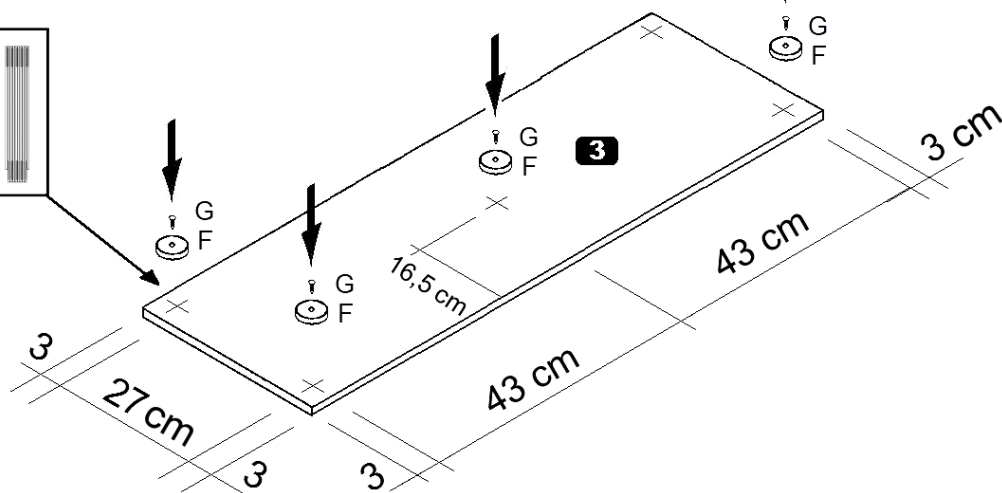
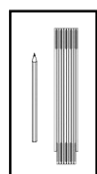
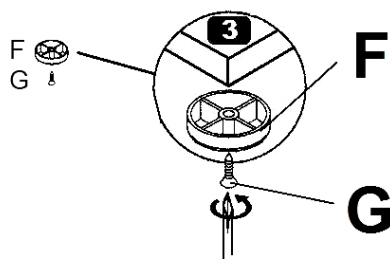
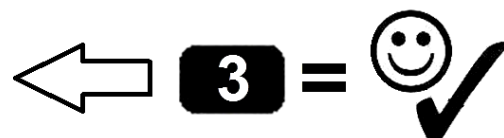
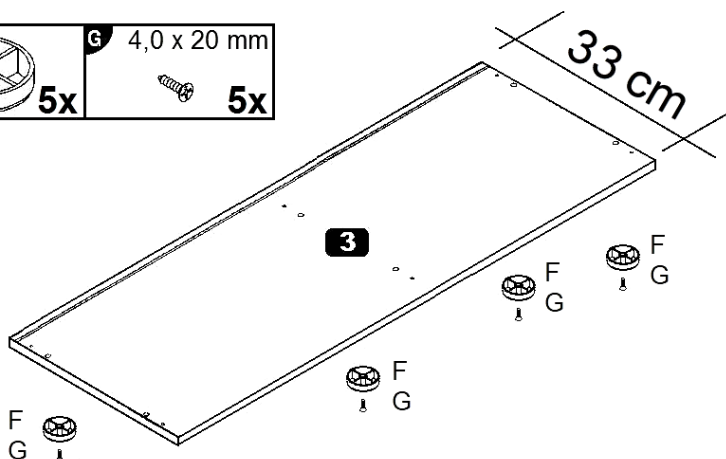
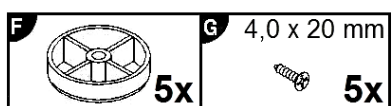

**1**

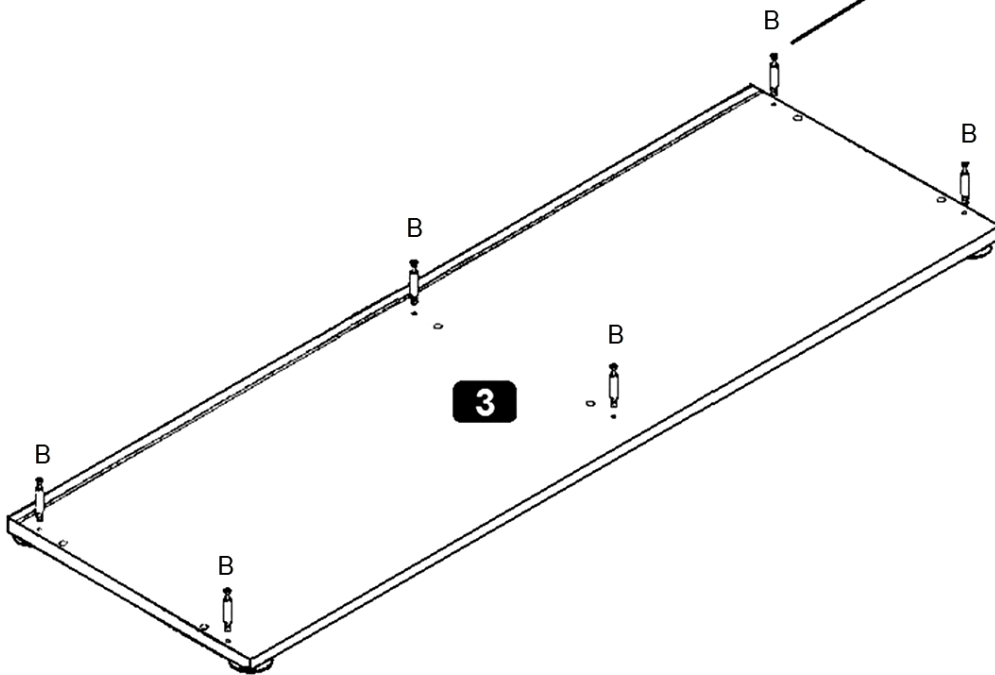
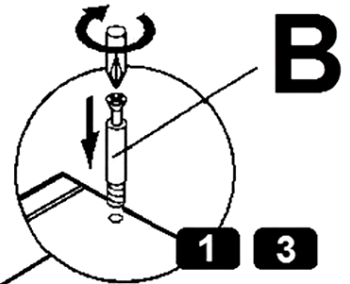
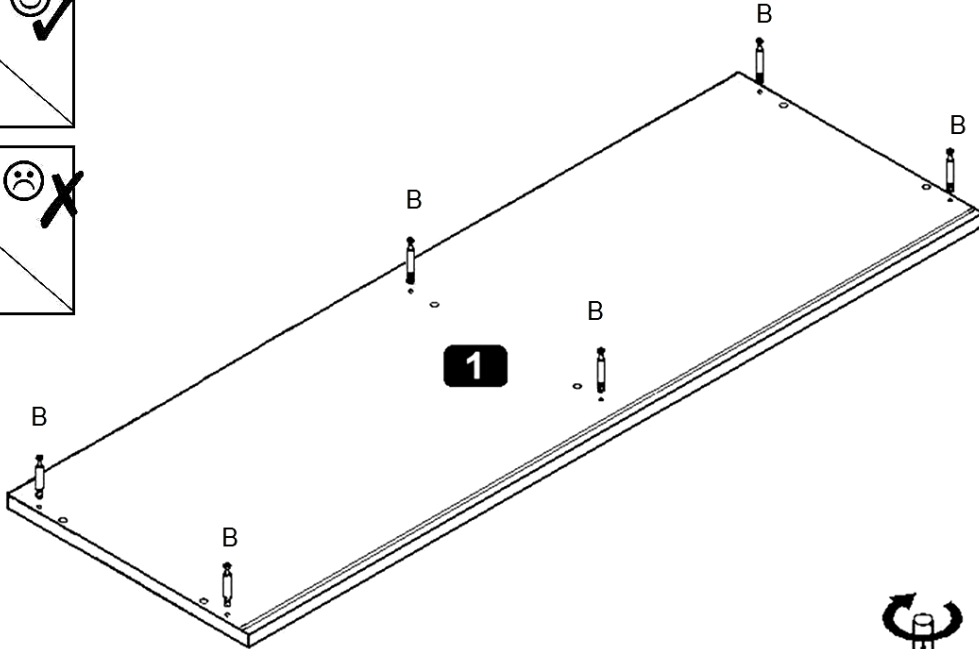
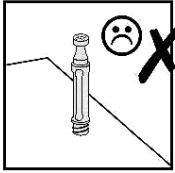
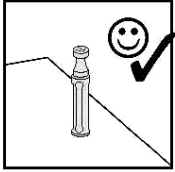
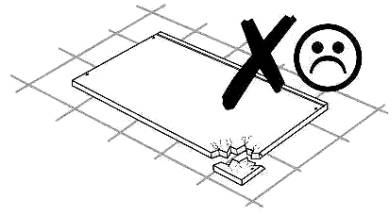
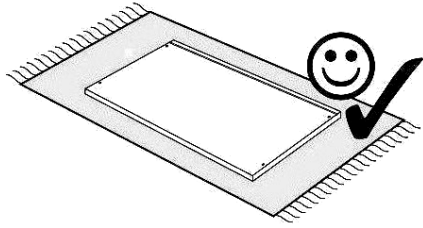
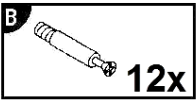

# 2



# 3

<b>A</b> 8,0 x 30 mm  12x	<b>C</b>  12x	<b>D</b>  4x	<b>E</b> 3,9 x 9,5 mm  8x	<b>I</b> h=2  8x
--	--	---	--	--

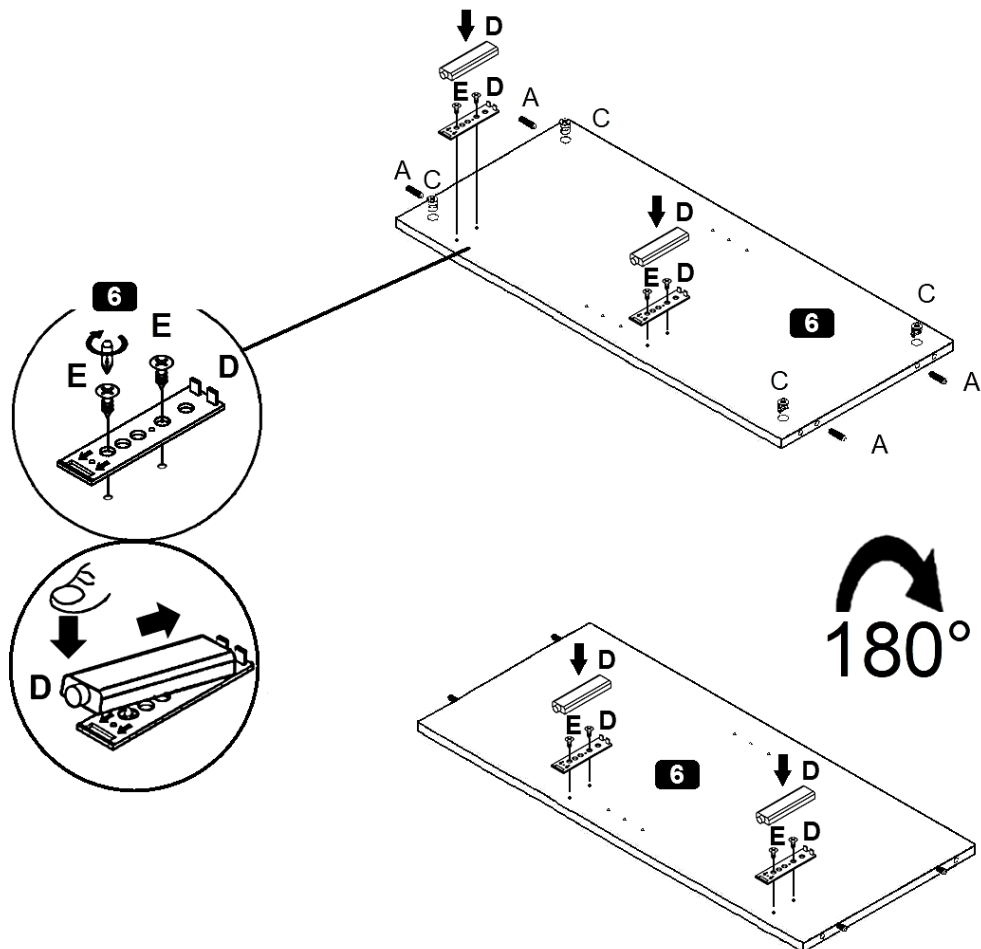
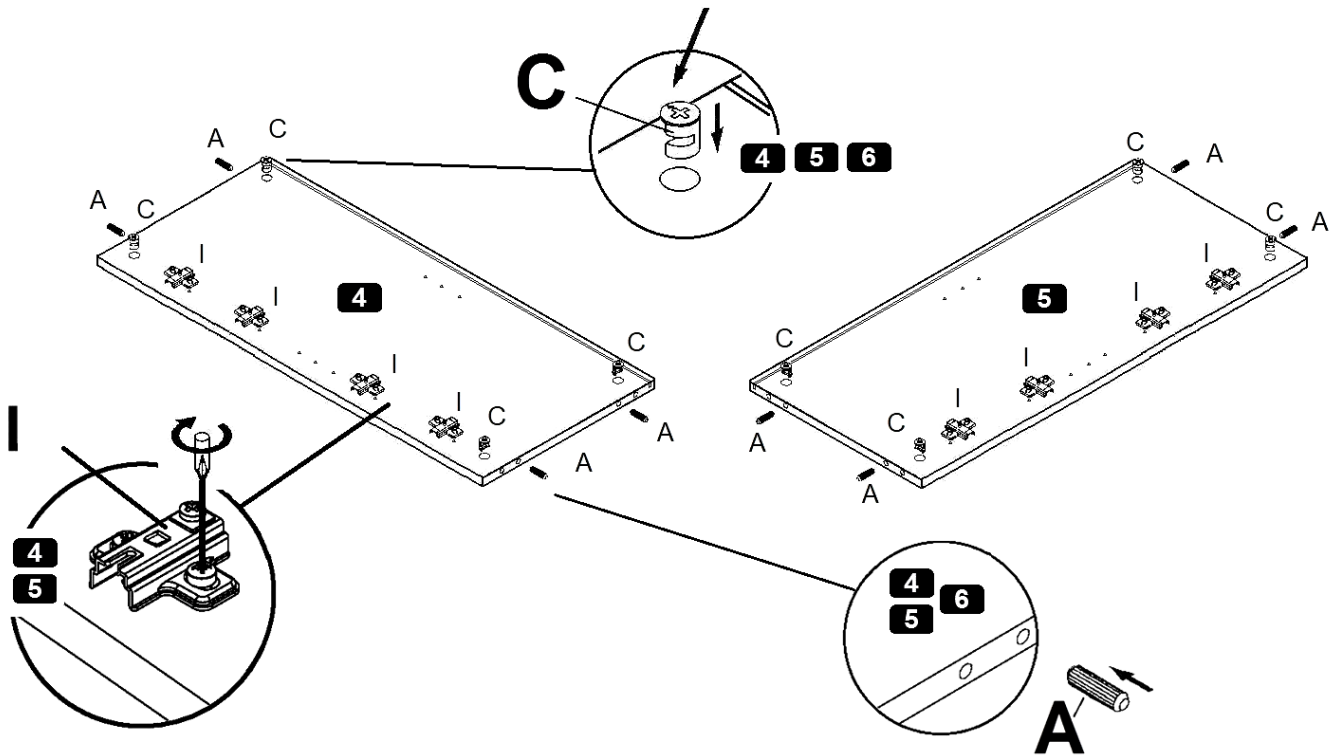
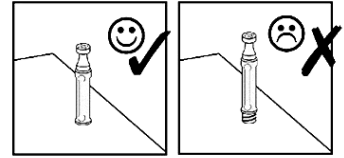

**4**

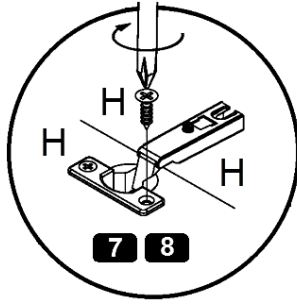
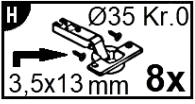

**7** ≠ **8**

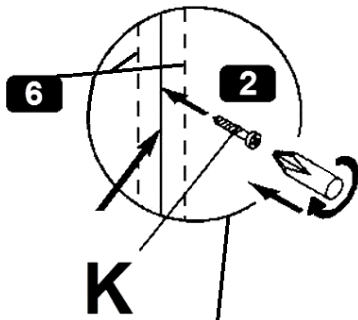
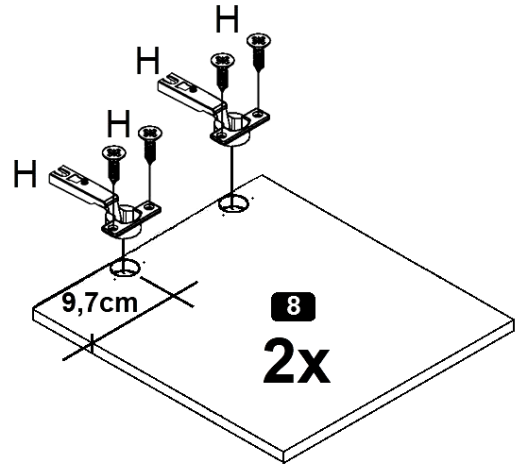
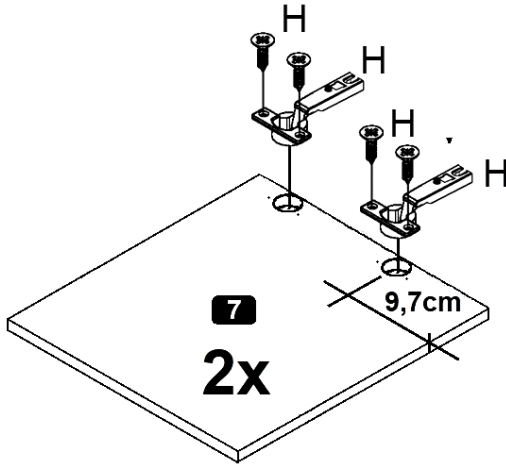

**4** ≠ **5**

**5**

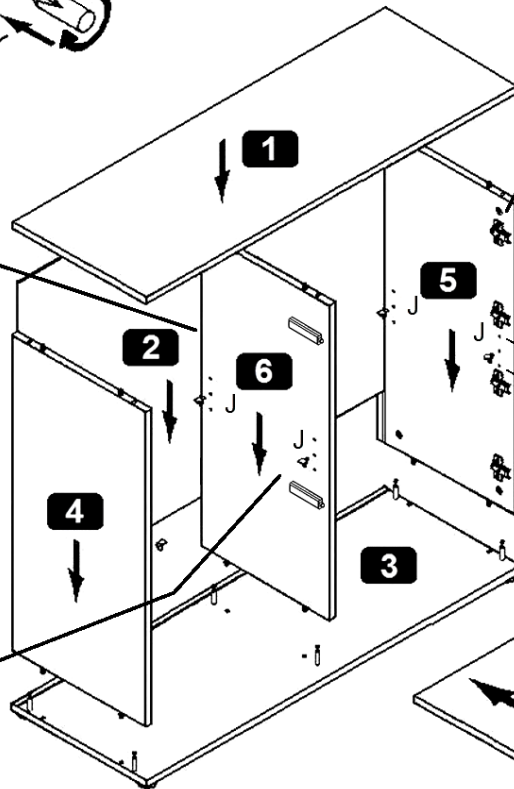
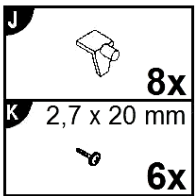

32,1cm

28,3cm

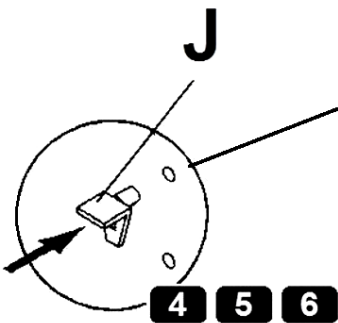

**4** = links / left

**5** = rechts / right

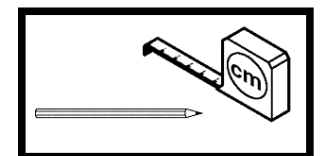

MA3



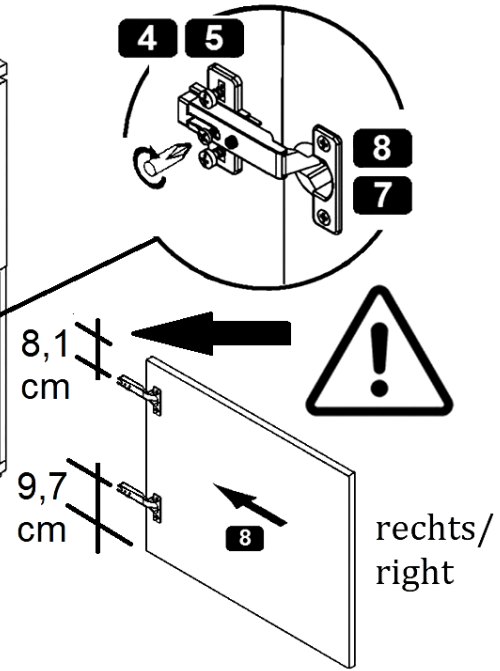
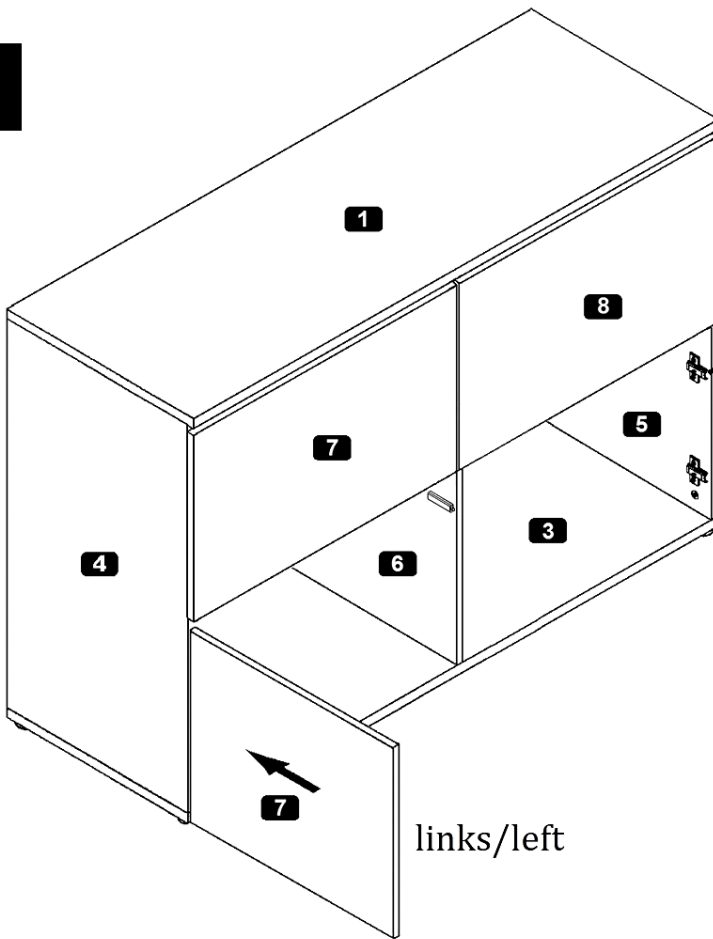

**6**



<b>8 / 9</b>	
<p>(D) <b>Push-To-Open einstellen</b></p> <p>(GB) Adjusting the Push-To-Open</p> <p>(FR) <b>Régler les Push-To-Open</b></p> <p>(IT) Sistemare Push-To-Open</p> <p>(NL) <b>Push-To-Open instellen</b></p> <p>(PL) Nastawić Push-To-Open</p> <p>(CZ) <b>Vyrovnejte Push-To-Open</b></p> <p>(RO) Nastavenie Push-To-Open</p> <p>(HU) <b>Állítsa be az Push-To-Open</b></p> <p>(SK) Reglare Push-To-Open</p> <p>(TR) <b>Push-To-Open ayarlanması</b></p> <p>(RU) Регулировка Push-To-Open</p>	

<b>9 / 9</b>	
<p>(D) <b>Türen einstellen</b> (Scharniere justieren)</p> <p>(GB) Adjusting the doors (adjusting the hinges)</p> <p>(FR) <b>Régler les portes</b> (ajuster les charnières)</p> <p>(IT) Sistemare le porte (regolare le cerniere)</p> <p>(NL) <b>Deuren instellen</b> (scharnieren afstellen)</p> <p>(PL) Nastawić drzwi (wyregulować zawiasy)</p> <p>(CZ) <b>Vyrovnejte dvířka</b> (seřid'te závěsy)</p> <p>(RO) Nastavenie dverí (nastavenie závesov)</p> <p>(HU) <b>Állítsa be az ajtókat</b> (állítsa be a zsanérokát)</p> <p>(SK) Reglare uši (ajustare balamale)</p> <p>(TR) <b>Kapıların ayarlanması</b> (menteşelerin seviye ayarı)</p> <p>(RU) Регулировка дверей (регулировка шарнира)</p>	

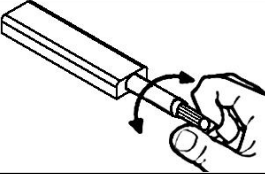
**7**

		
<b>(D)</b> Push-To-Open einstellen	<b>(CZ)</b> Vyrovnajte Push-To-Open	
<b>(GB)</b> Adjusting the Push-To-Open	<b>(RO)</b> Nastavenie Push-To-Open	
<b>(FR)</b> Régler les Push-To-Open	<b>(HU)</b> Állítsa be az Push-To-Open	
<b>(IT)</b> Sistemare Push-To-Open	<b>(SK)</b> Reglare Push-To-Open	
<b>(NL)</b> Push-To-Open instellen	<b>(TR)</b> Push-To-Open ayarlanması	
<b>(PL)</b> Nastawić Push-To-Open	<b>(RU)</b> Регулировка Push-To-Open	

**1.**

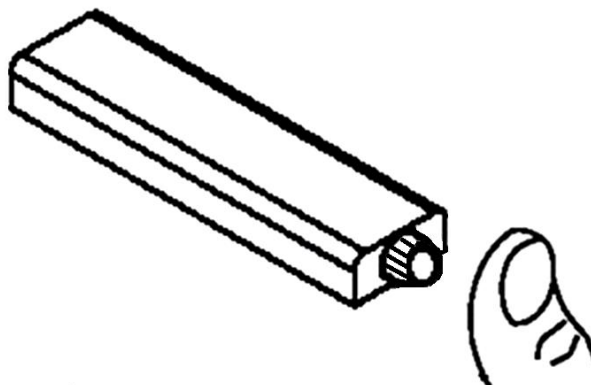

**2.**

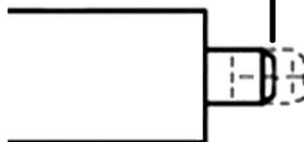
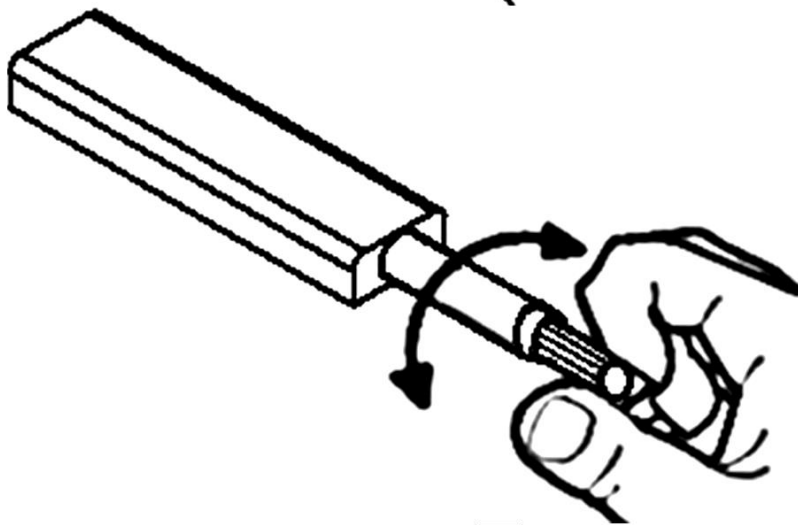



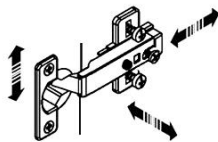

**(D)** Türen einstellen  
(Scharniere justieren)

**(GB)** Adjusting the doors  
(adjusting the hinges)

**(FR)** Régler les portes  
(ajuster les charnières)

**(IT)** Sistemare le porte  
(regolare le cerniere)

**(NL)** Deuren instellen  
(scharnieren afstellen)

**(PL)** Nastawić drzwi  
(wyregulować zawiasy)

**(CZ)** Vyrovnajte dvířka  
(seřid'te závěsy)

**(RO)** Nastavenie dverí  
(nastavenie závesov)

**(HU)** Állítsa be az ajtókat  
(állítsa be a zsanérokot)

**(SK)** Reglare uši  
(ajustare balamale)

**(TR)** Kapıların ayarlanması  
(menteşelerin seviye ayarı)

**(RU)** Регулировка дверей  
(регулировка шарнира)

