



**D** Montageanleitung

**F** Notice de montage

**NL** Handleiding voor de montage

**CZ** Monzáni návod

**HU** Szerelési útmutató

**TR** Montaj talimatı

**GB** Assembly instructions

**I** Istruzione di montaggio

**PL** Instrukcja montaży

**SK** Návod na montáž

**RO** Instrucțiuni de montaj

**RU** ИНСТРУКЦИЯ ПО МОНТАЖУ

Art. Nr. 3140

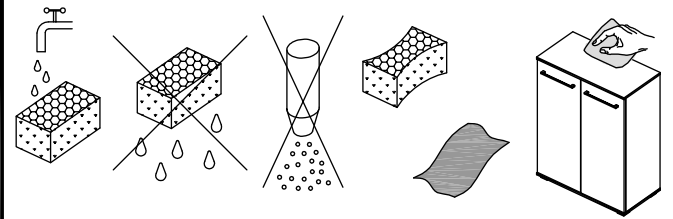
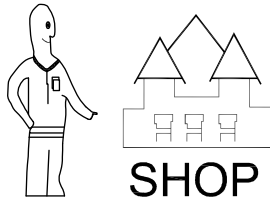
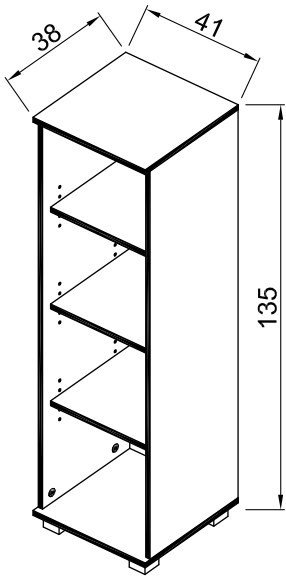

Art. Nr. 3140

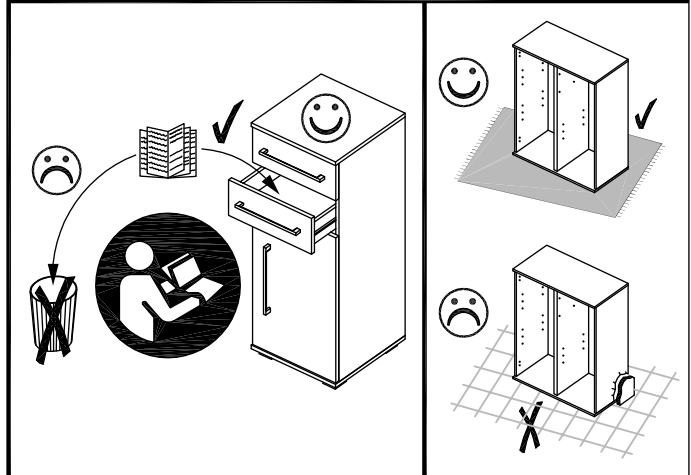
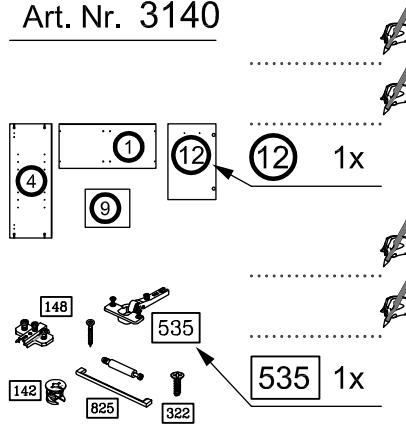

 3,5 x 35 <b>102</b> <b>8x</b>	 Ø 15 x 11,5 <b>142</b> <b>8x</b>
 6 x 44 <b>143</b> <b>8x</b>	 <b>528</b> <b>4x</b>
 2,7 x 20 <b>906</b> <b>32x</b>	 <b>916</b> <b>12x</b>

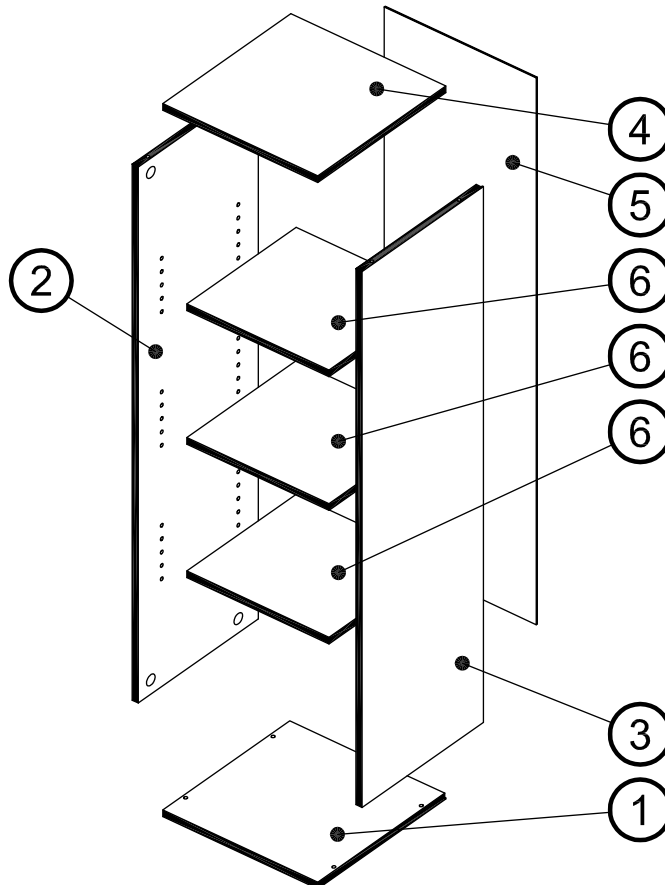

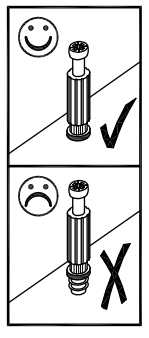
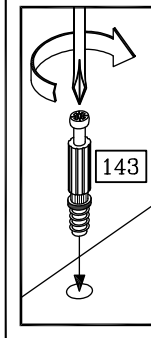
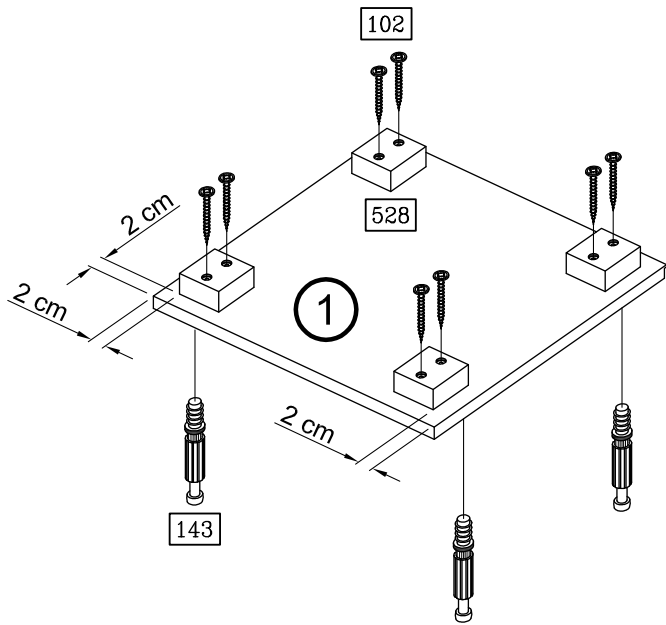
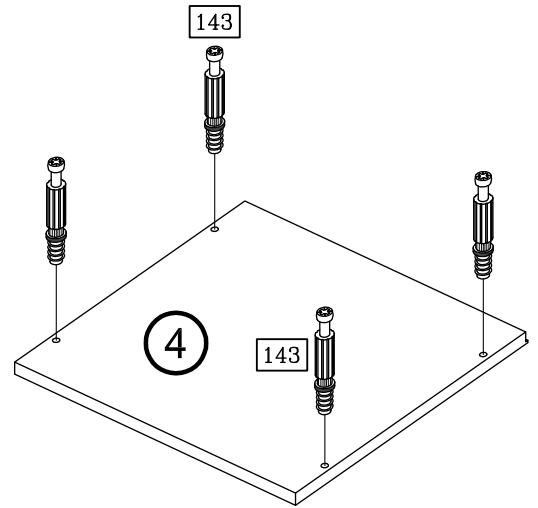
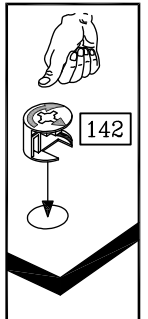
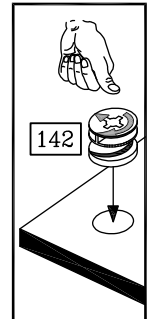
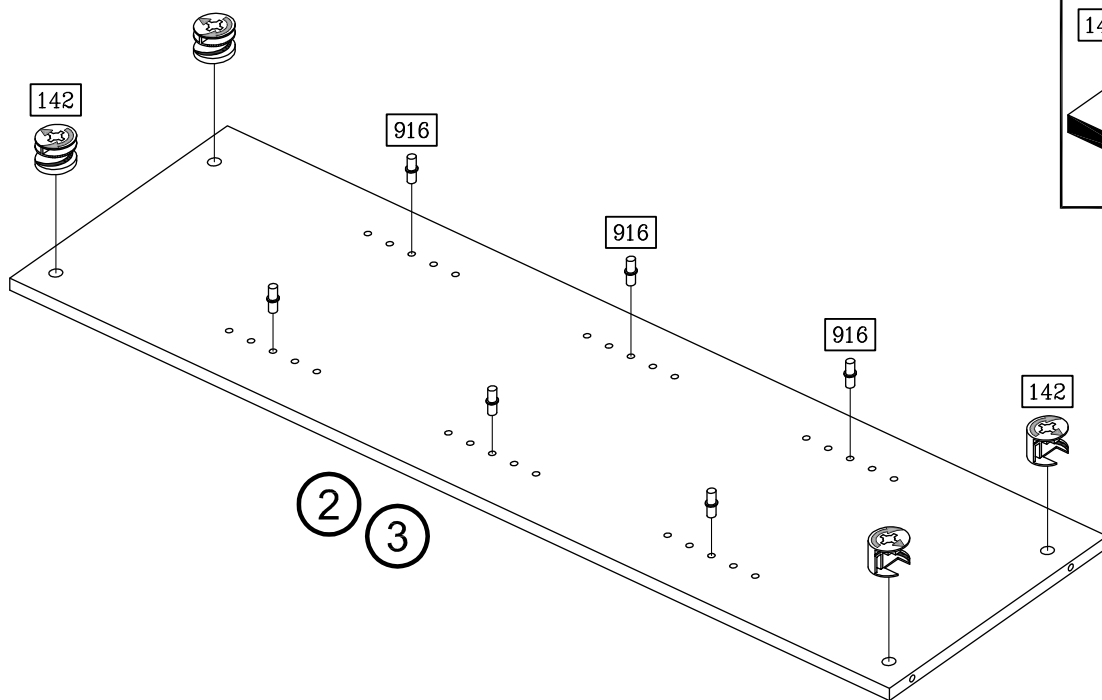
**1****2****3**

3140-1211

2/4

4

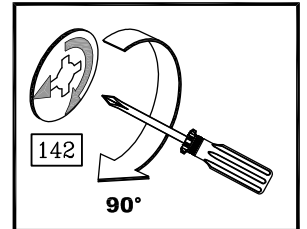
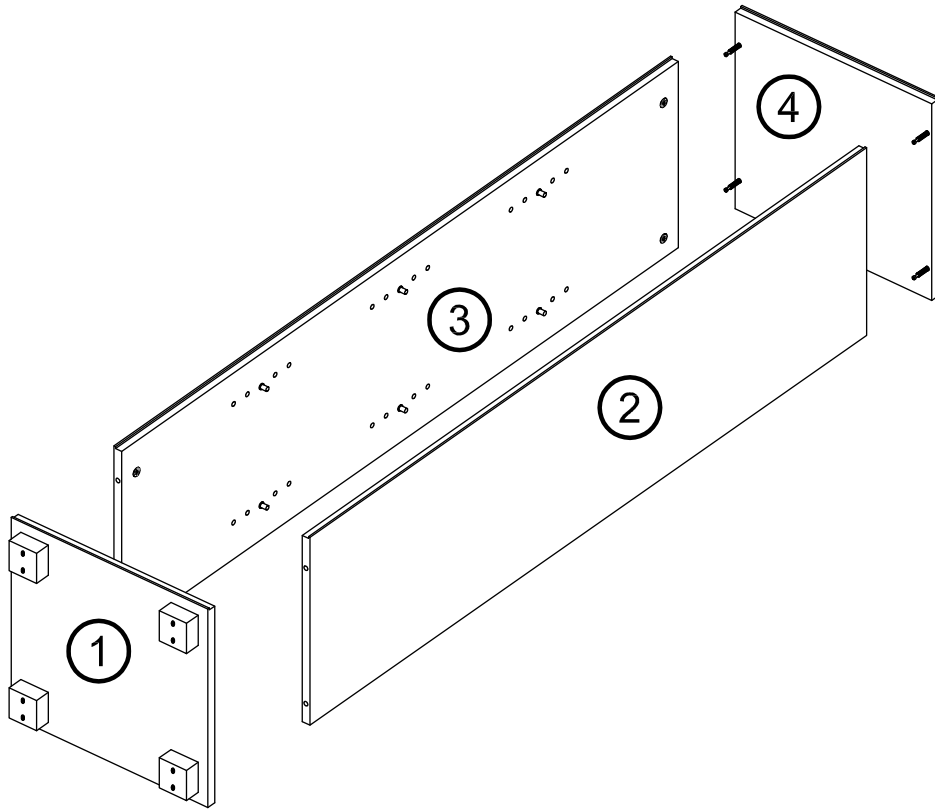

5

