

Montageanleitung von sessel

OSKAR

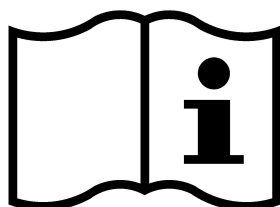

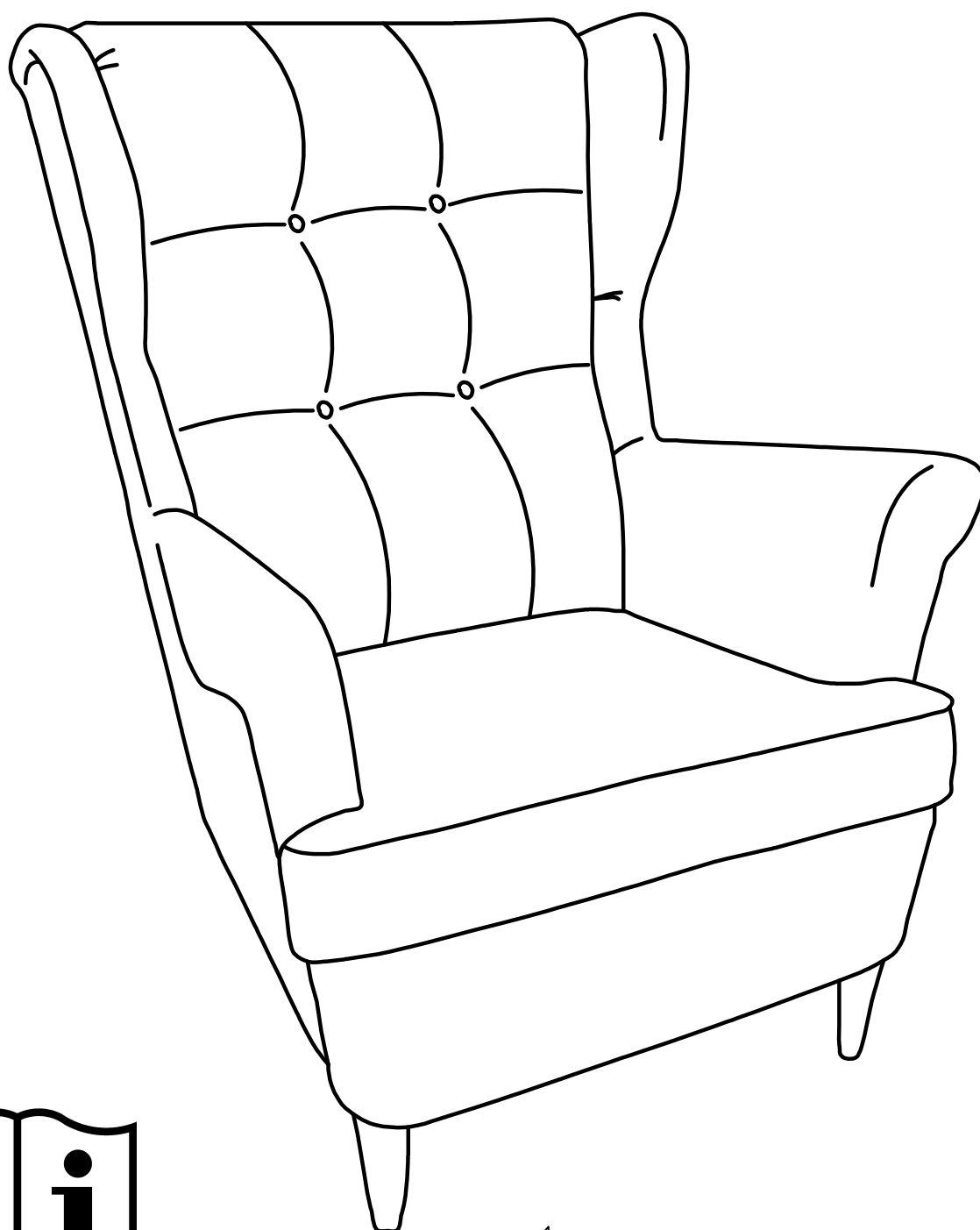

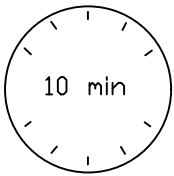



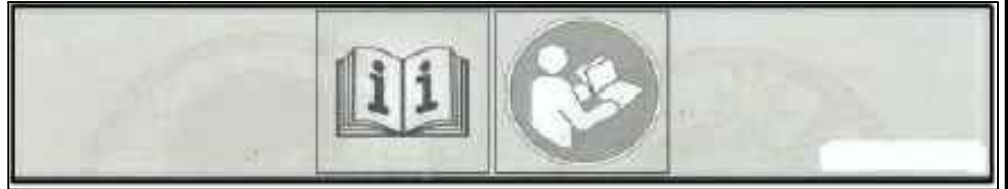

10 min



Schraubenschlüssel 13

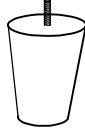

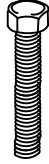
Elemente in einem Satz

<p>A</p>  <p>L=135 x 2</p>	<p>B</p>  <p>L=120 x 2</p>	<p>C</p>  <p>x 4</p>	<p>D</p>  <p>x 4</p>	<p>E</p>  <p>M8X65 x 6</p>	<p>K</p>  <p>M8x 6</p>
---	---	---	---	---	---

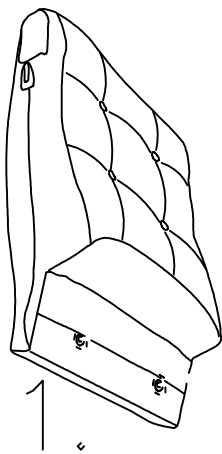

1.

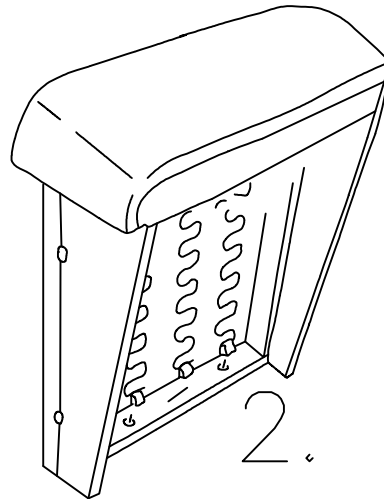

2.

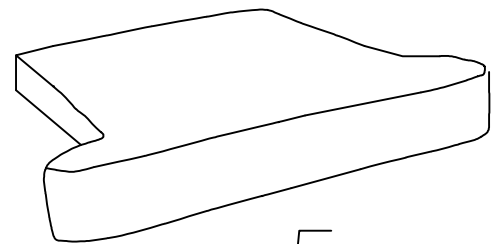

5.

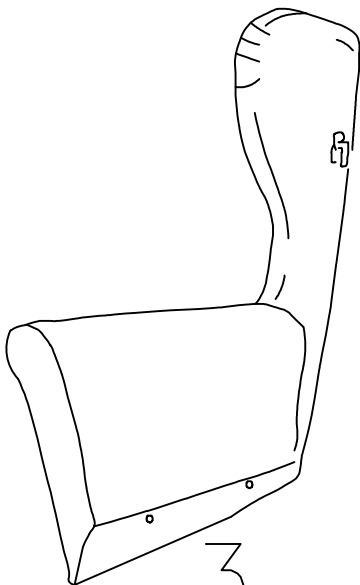

3.

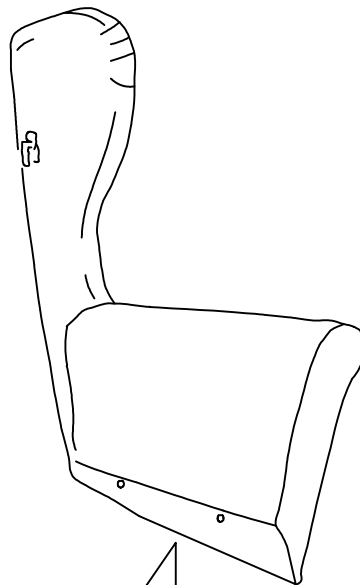

4.

1.

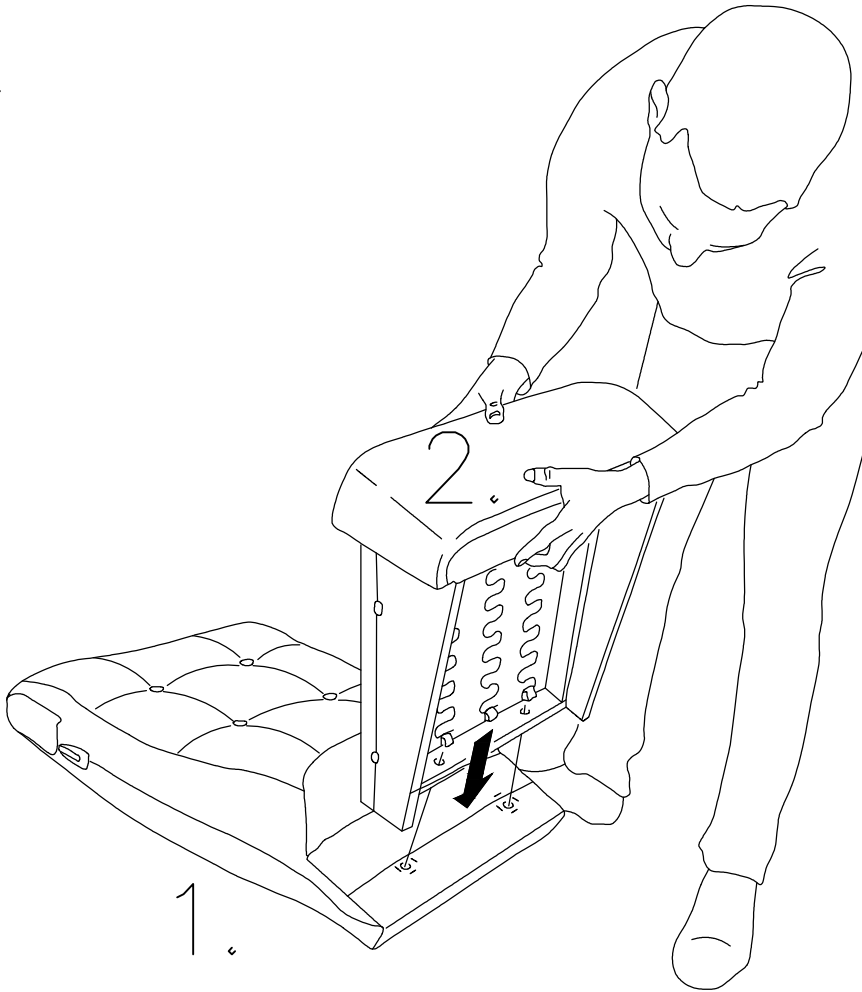
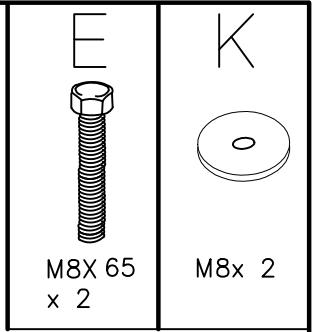

2.

1.

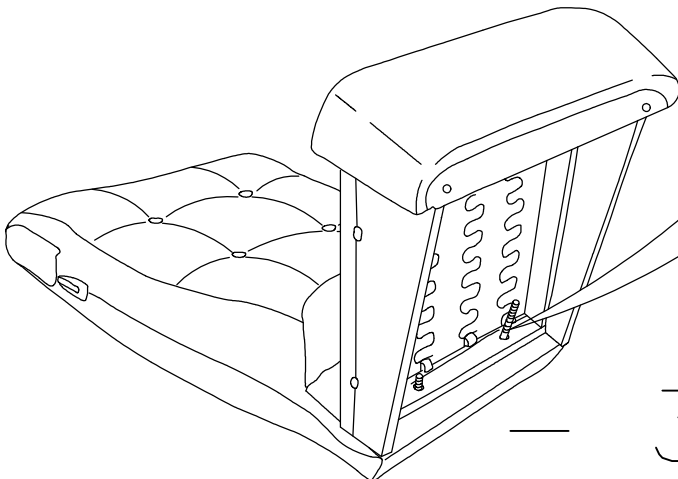
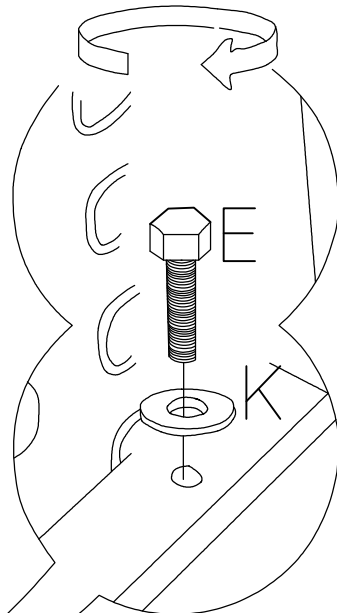

— 3 —

3.

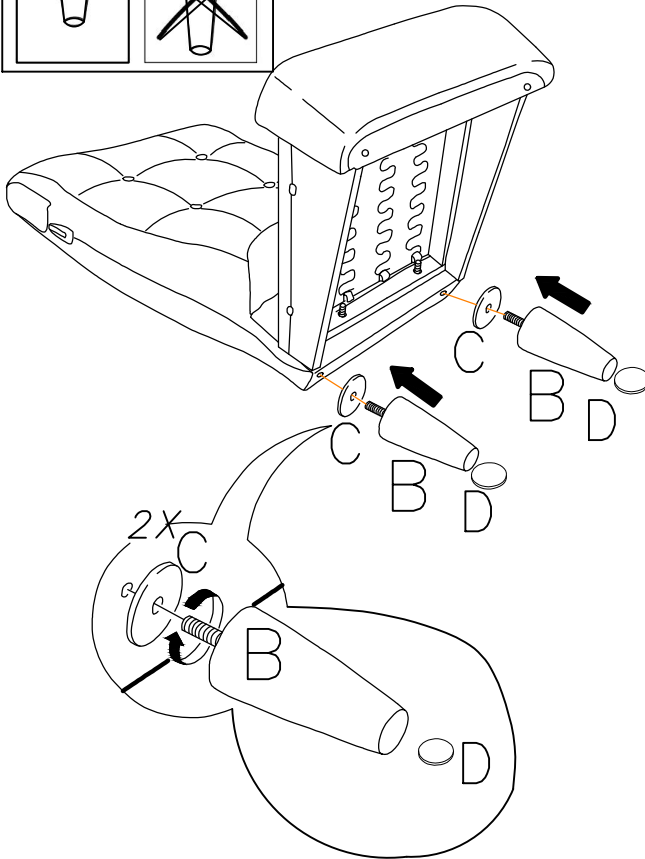
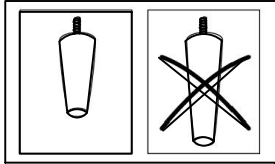

B	C	D
L=120 x 2	x 2	x 2

4.

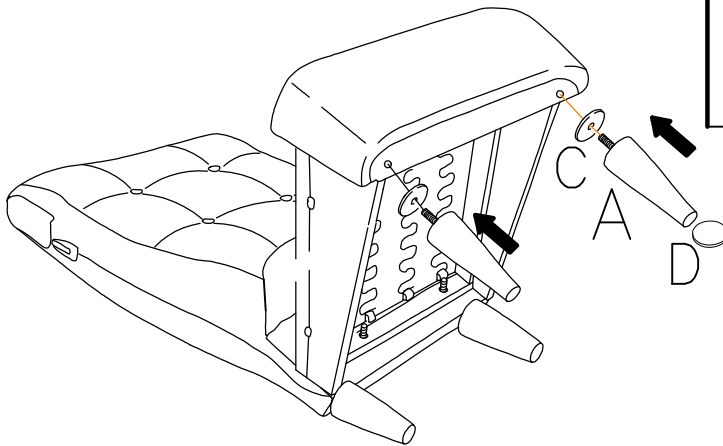

A	C	D
L=135 x 2	x 2	x 2

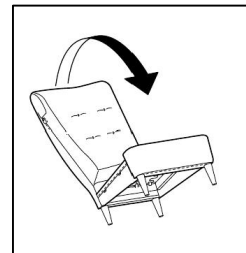
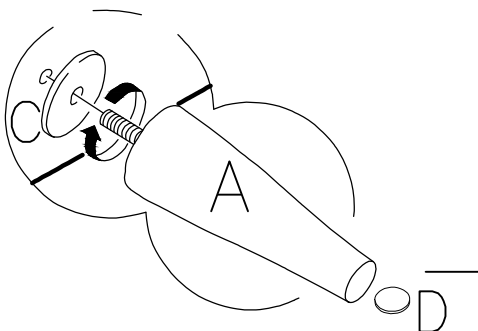

4

5.

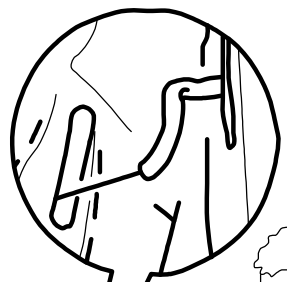

Nr 1
Einhängebeschlag
(Rückenlehne)

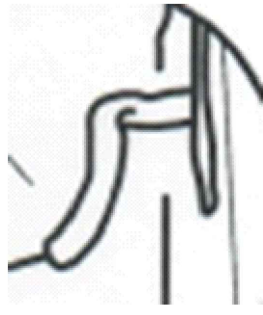
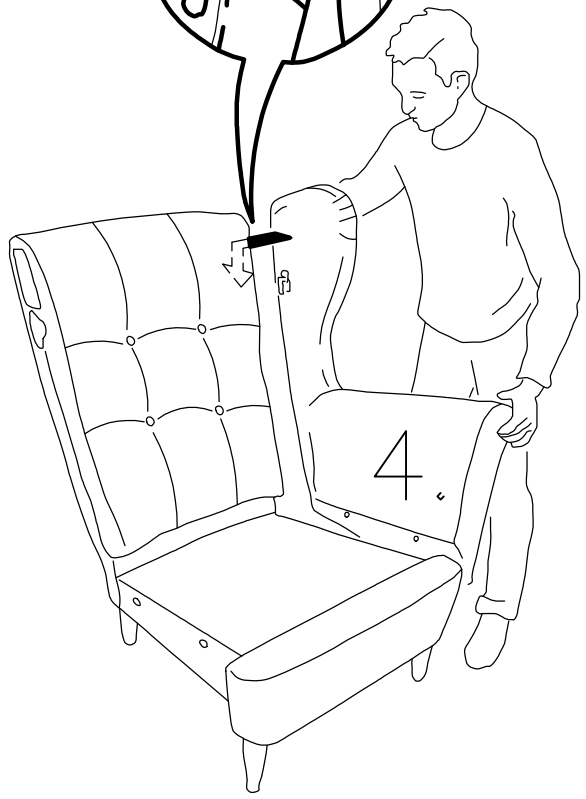

Nr 2
Aufhänger
(Gegenstück für
Einhängebeschlag)

6.

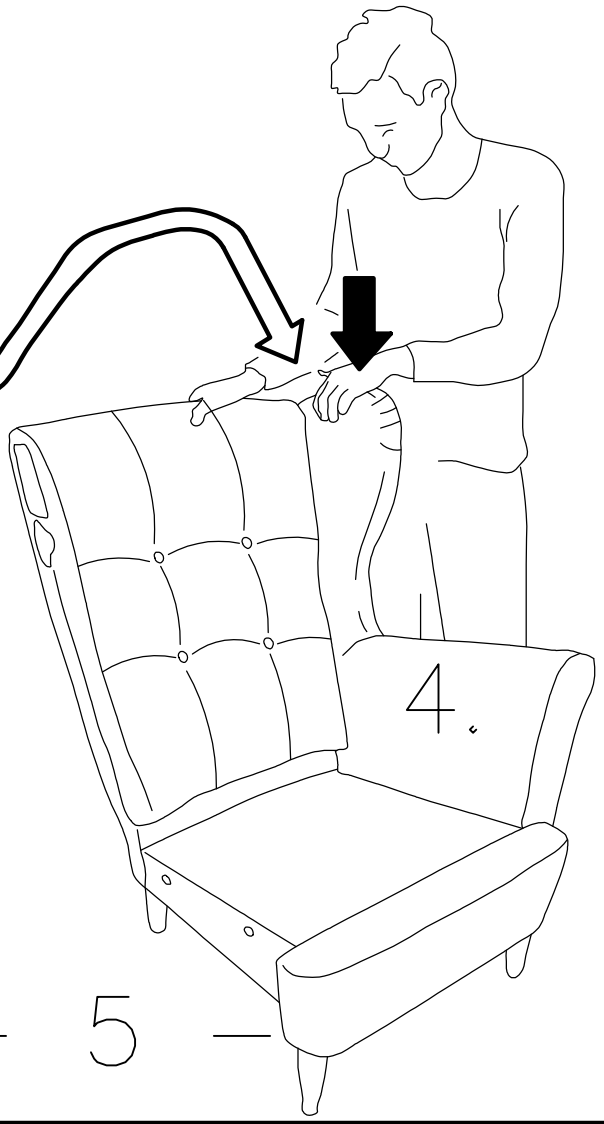
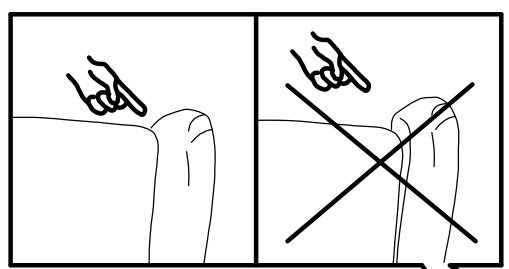

— 5 —

7.

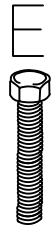
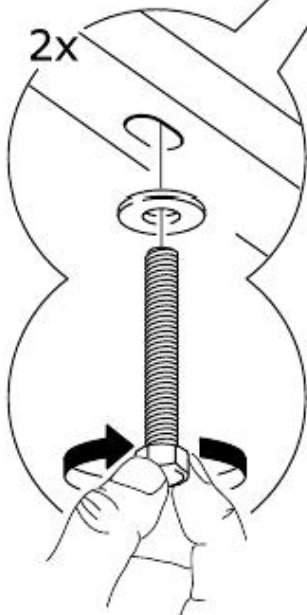
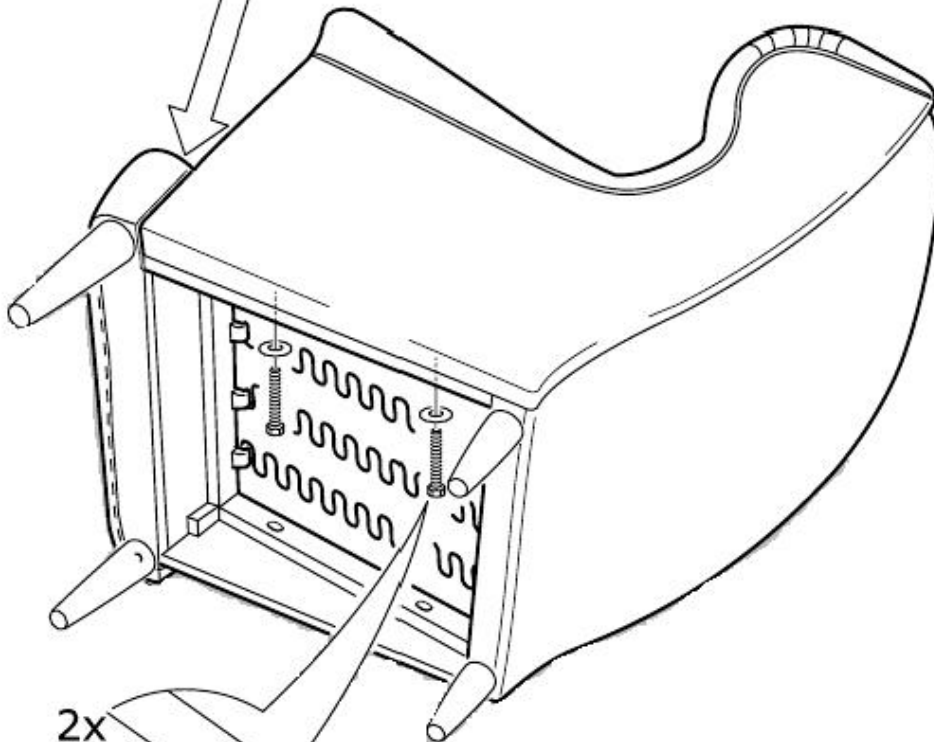
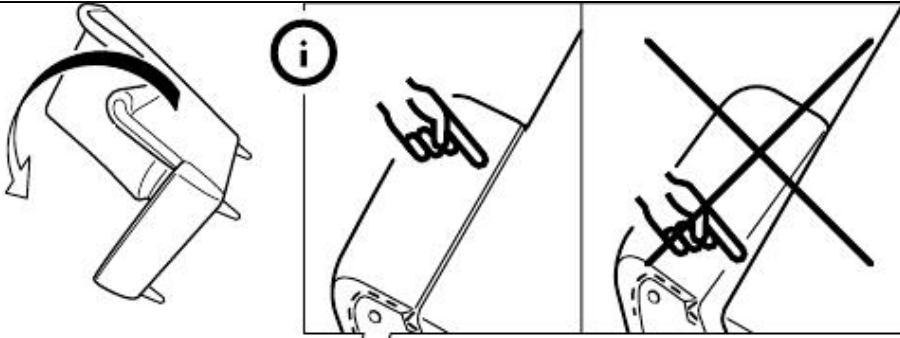

M8X65
x 2

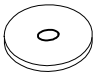

M8x 2

8.

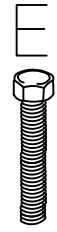

M8X65
x 2

K

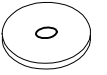

M8x 2

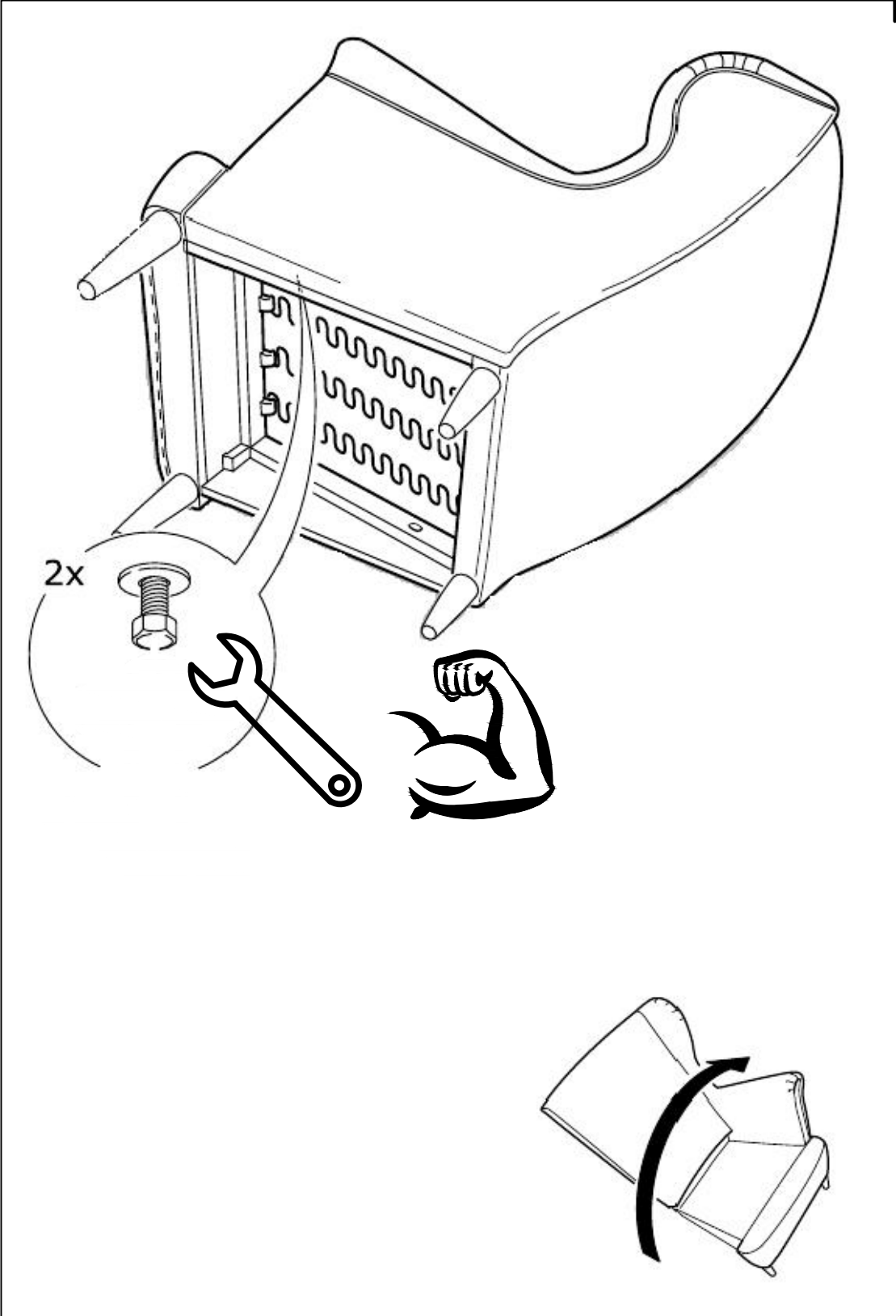

9. Die zweite Seitenwand ist Analog zu den Punkten 6–9 zu montieren.

10.

