

Attenzione Warning Achtung Attention



0-10

Keep children away from packaging material.
Tenere il materiale di imballo fuori dalla portata dei bambini.
Verpackungsmaterial von Kinder fernhalten.
Garder le matériel d' emballage hors de portée des enfants.



Do not put items directly on furniture surface.
Non porre direttamente sulla superficie del divano oggetti che potrebbero danneggiarla.
Keine Gegenstände auf den Bezug des Sofas legen, die diesen beschädigen könnten.
Ne pas appuyer directement sur la surface du canapé des objets qui pourraient l' endommager.



Do not clean furniture with harsh cleansers or polish.
Non pulire il divano con prodotti aggressivi o lucidanti.
Das Sofa weder mit aggressiven noch mit glänzend machenden Mitteln reinigen.
Ne pas nettoyer le canapé avec des produits agressifs ou brillants.



Do not place furniture in direct sunlight.
Non porre la merce direttamente in contatto con la luce del sole.
Das Sofa nicht unter direkter Sonnenlichteinstrahlung aussetzen.
Ne pas mettre la marchandise directement en contact avec la lumière du soleil.



Do not place furniture near heating or cooling vents.
Non porre la merce in prossimità di condizionatori o fonti di calore.
Das Sofa nicht in unmittelbarer Nähe von Heizkörpern oder Klimaanlage positionieren.
Ne pas mettre la marchandise à proximité de climatiseurs ou sources de chaleur.



Do not write on furniture.
Non scrivere sulla superficie del divano.
Nicht auf dem Bezug schreiben.
Ne pas écrire sur la surface du canapé.



Do not place furniture outside. For indoor use only.
Non porre il divano all'aperto. Solo per uso in ambienti chiusi.
Nicht im Freien aussetzen. Nur fuer internen Gebrauch verwendbar.
Ne pas disposer le canapé en plain air. Son usage est seulement pour des endroits fermés.

Cura e Manutenzione Care & Maintenance Reinigung & Pflege Nettoyage et entretien



Microfiber: Dust and pick-up spills using a clean non- colored, lint-free cloth.
Microfibra: Pulire con un panno pulito non colorato.
Mikrofaser: Mit einem sauberen farblosen Tuch. reinigen.
Microfibre: Nettoyer avec un chiffon non de couleur.



Leather: Stains may be removed with mild soap solution and damp cloth.
Pelle: Rimuovere eventuali macchie con una soluzione composta da acqua e sapone neutro e un panno asciutto.
Leder: Eventuelle Flecken mit einem Wasser- und neutralem Seifen-Mix entfernen und mit trockenem Tuch abtupfen.
Cuir: Enlever des taches éventuelles avec une solution composé d' eau et savon neutre et un chiffon sec.

1) a

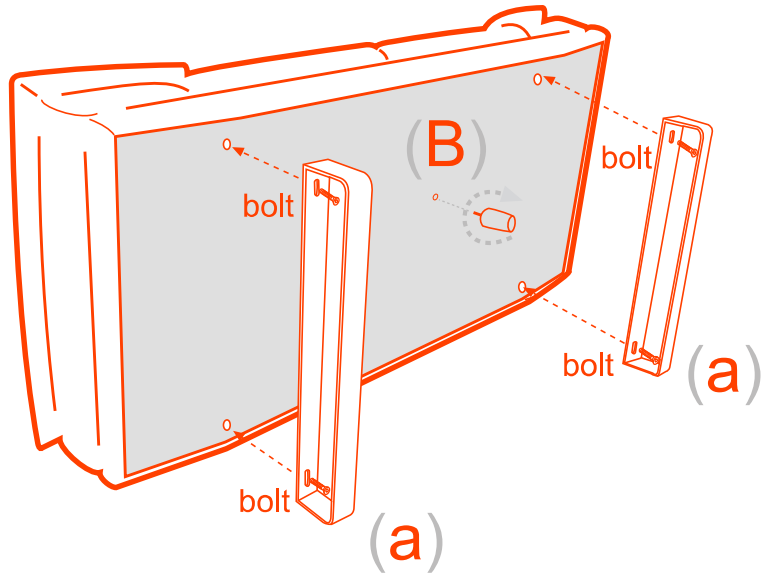

1) b

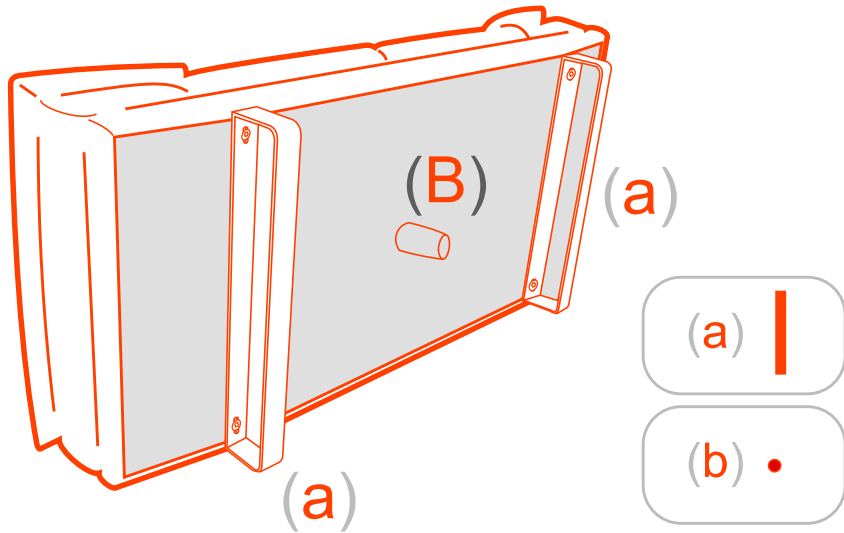

200

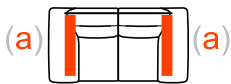

240

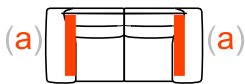

300

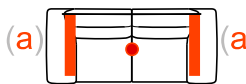

243

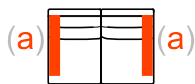

252L 251R

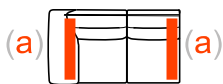

320L 310R



348L 347R

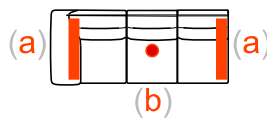

000



096L 095R



602L 601R

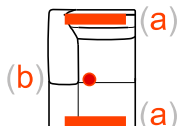

420L 410R

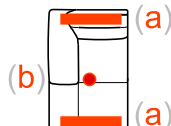

635



1) a

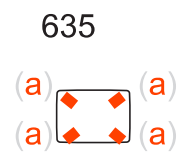
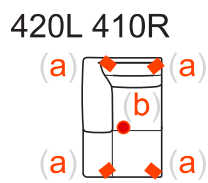
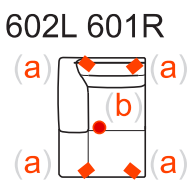
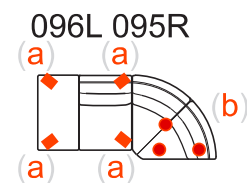
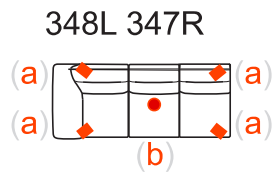
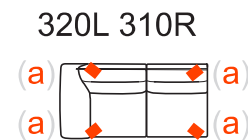
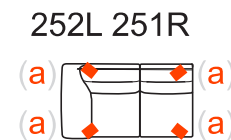
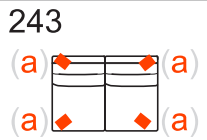
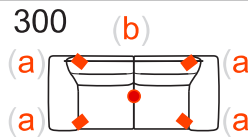
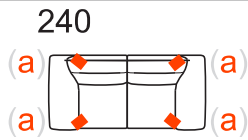
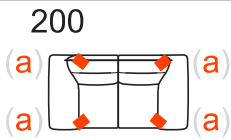
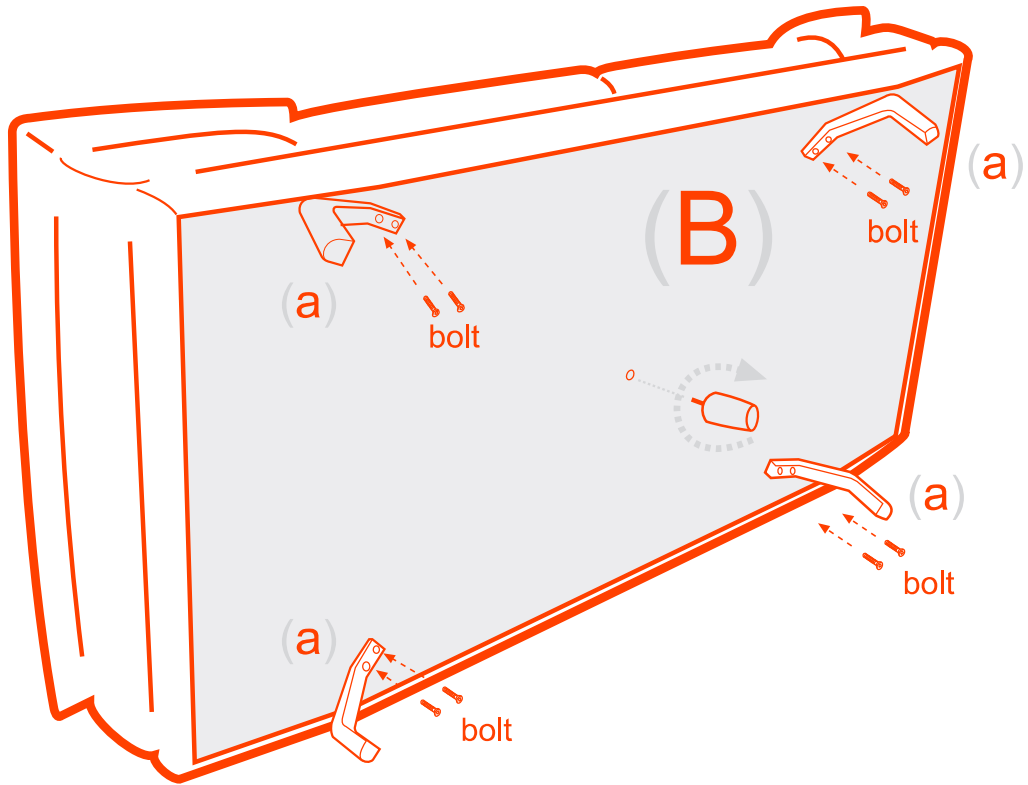

1)

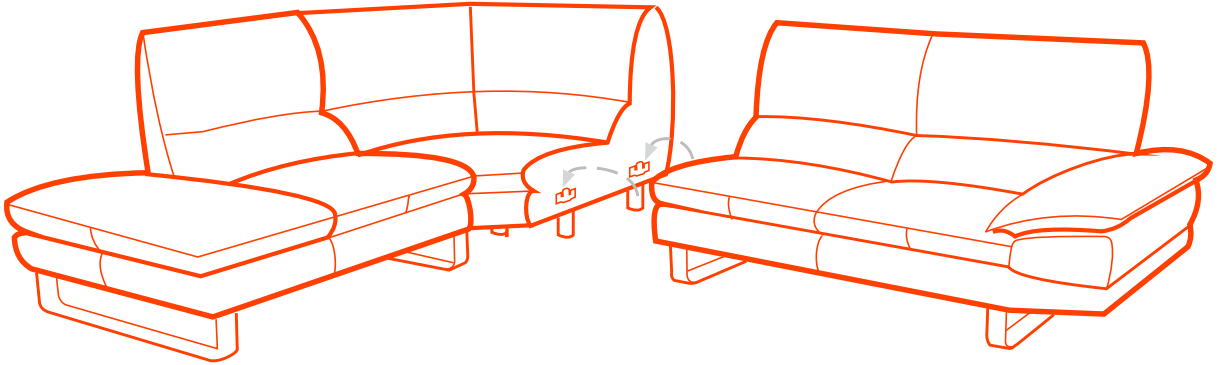

2)

