

PALE/PALOMINO
2071-5010-3300
3100-5010-2073

- | | | | |
|-----------|--|-----------|---|
| D | MONTAGEANLEITUNG
BEDIENUNGSANLEITUNG | GB | ASSEMBLY INSTRUCTIONS
INSTRUCTION MANUAL |
| NL | HANDLEIDING VOOR DE MONTAGE
GEBRUIKSAANWIJZING | PL | INSTRUKCJA MONTAŻU
INSTRUKCJA OBSŁUGI |
| TR | MONTAJ TALIMATI
KULLANIM KLAVUZU | RU | ИНСТРУКЦИЯ ПО МОНТАЖУ
ИНСТРУКЦИЯ ПО ЭКСПЛУАТАЦИИ |
| RO | INSTRUCȚIUNI DE INSTALARE
INSTRUCȚIUNI DE UTILIZARE | IT | ISTRUZIONI DI MONTAGGIO
MANUALE DI ISTRUZIONI |
| FR | NOTICE DE MONTAGE
MANUEL INSTRUCTIONS | SK | MONTÁŽNY NÁVOD
NÁVOD NA POUŽITIE |
| HU | KÖZGYŰLÉS UTASÍTÁSOK
KEZELÉSI UTASÍTÁS | CZ | MONTÁŽNÍ NÁVOD
NÁVOD K POUŽITÍ |
| SI | NAVODILA ZA MONTAŽO
NAVODILA ZA UPORABO | PT | INSTRUÇÕES DE MONTAGEM
MANUAL DO USUÁRIO |
| ES | INSTRUCCIONES DE MONTAJE
MANUAL DEL USUARIO | HR | UPUTE ZA MONTAŽU
UPUTE ZA UPOTREBU |

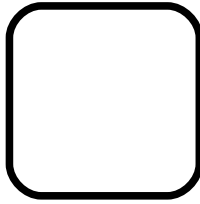

0019

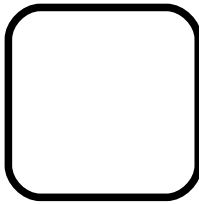
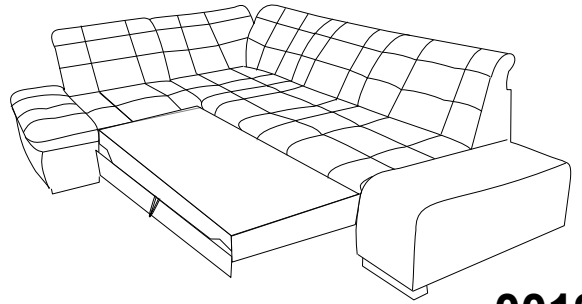
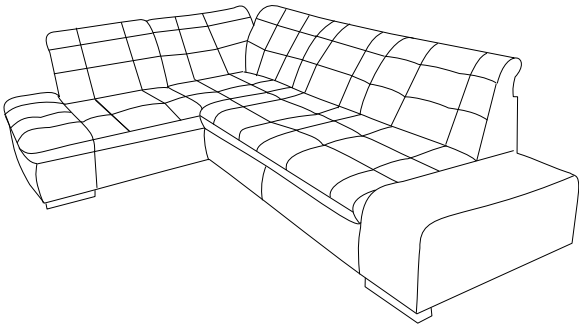





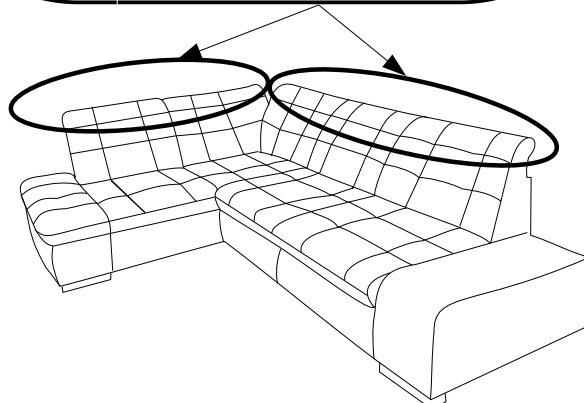
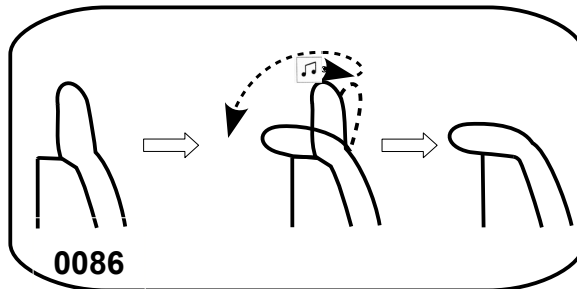
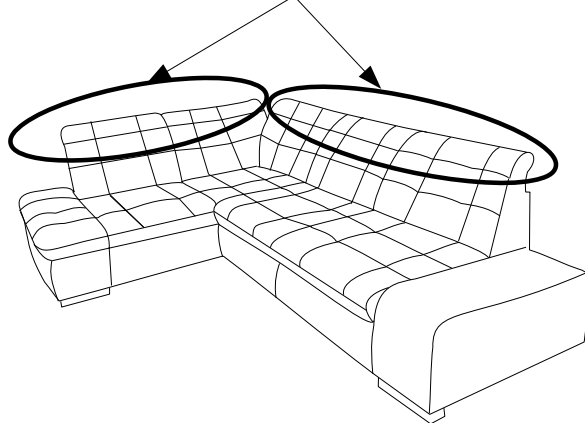
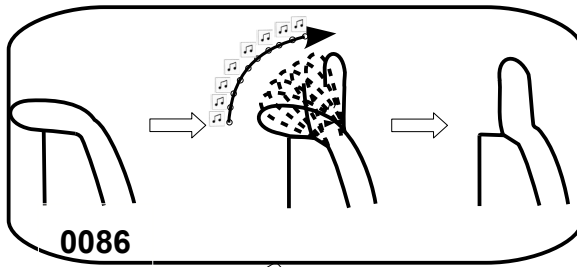

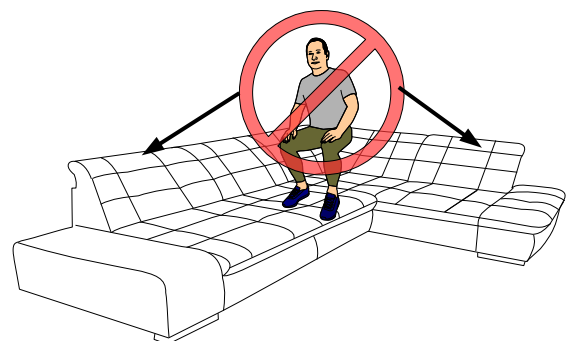
0019

0086







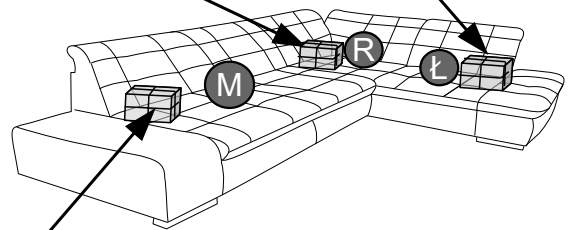
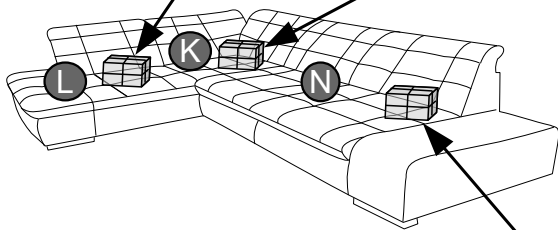

Z H-50  X1	y H-50  X1	X Fi-35  X5	d M5*50 [mm]  X4
--	--	---	---

g H-50  X4	X Fi-35  X4	d M5*50 [mm]  X4
--	---	--



Z H-50  X1	y H-50  X1	X Fi-35  X5	d M5*50 [mm]  X4
--	--	---	---

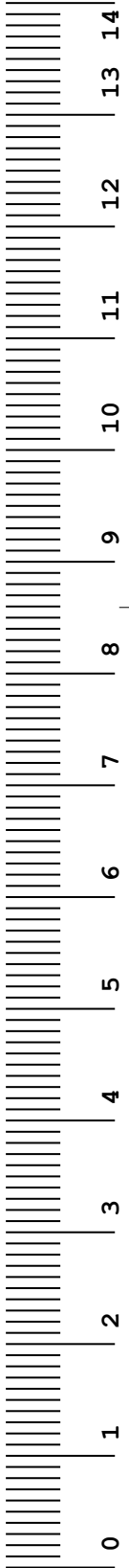
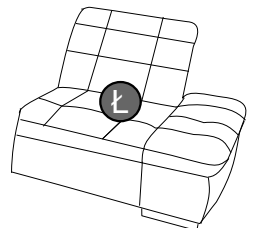
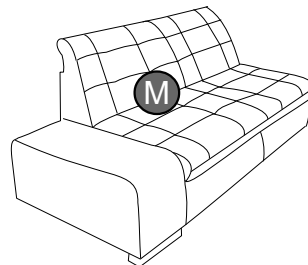
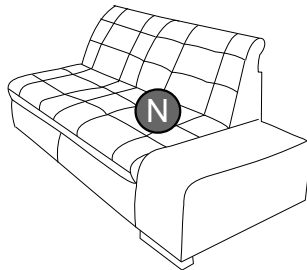
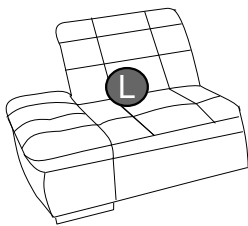
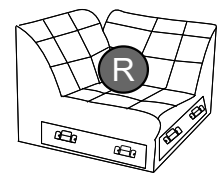
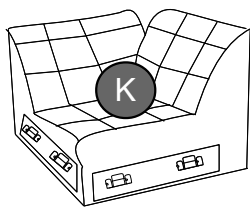

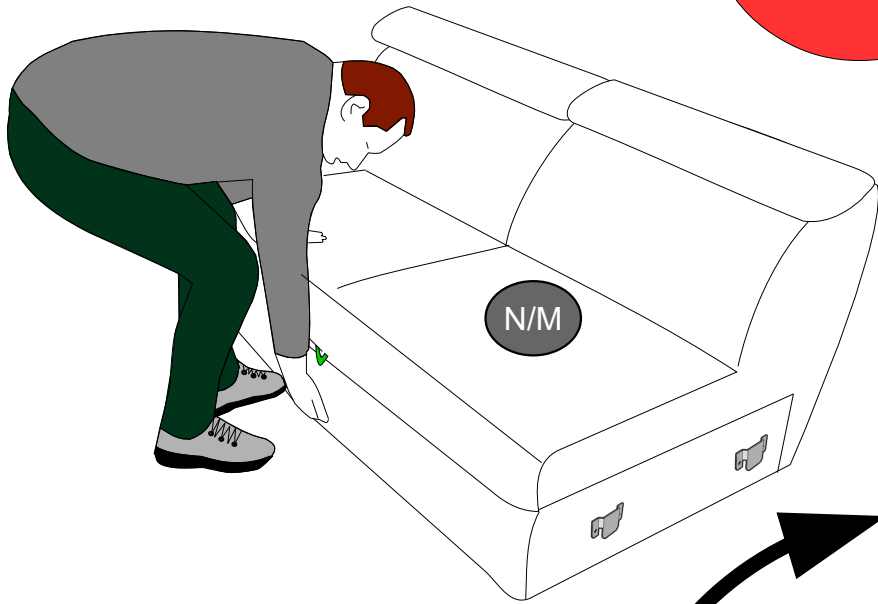



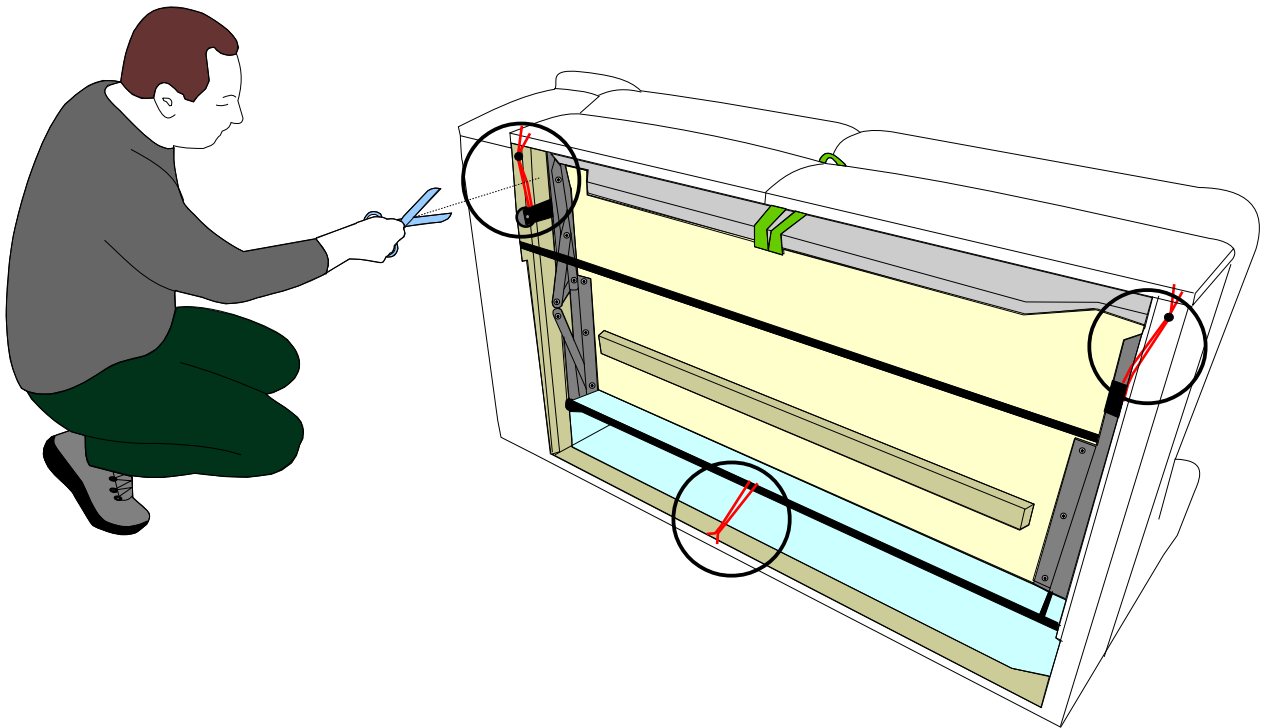

90°



0019

g H-50 	z H-50 	y H-50 	x Fi-35 	d M5*50 
X4	X2	X2	X14	X12

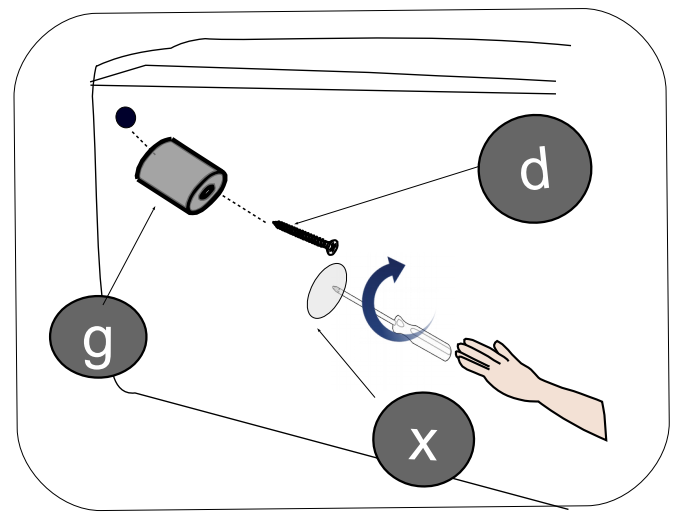
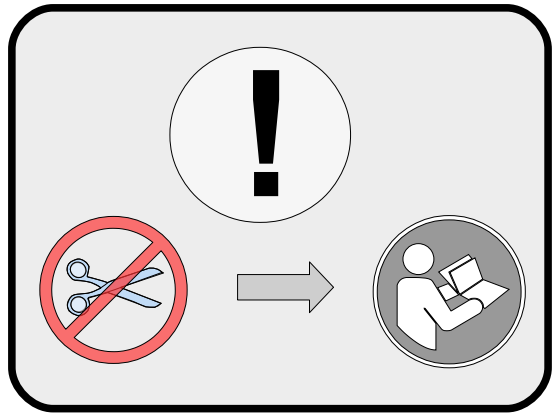
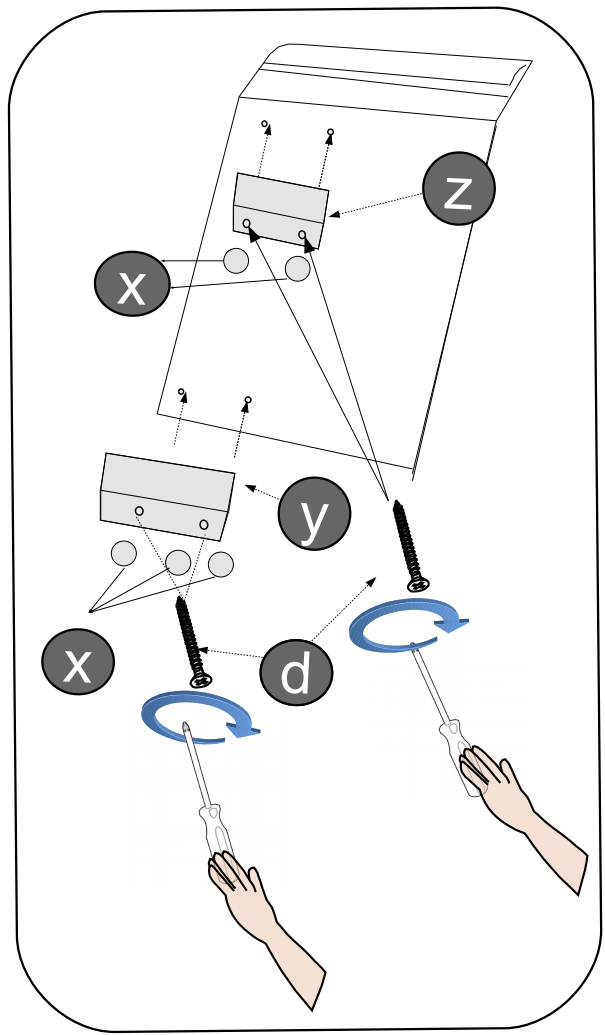
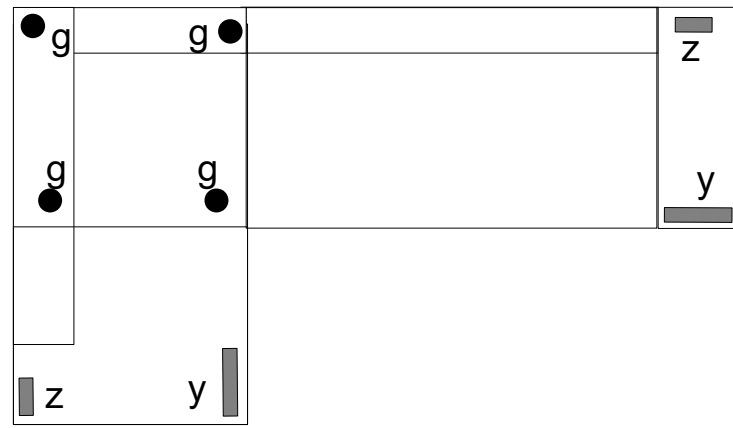
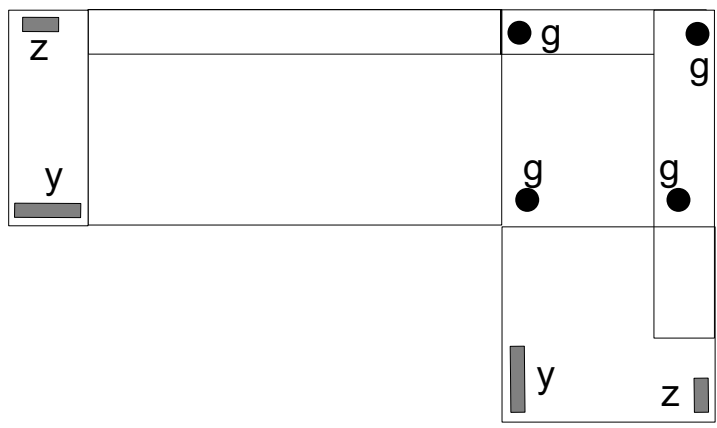
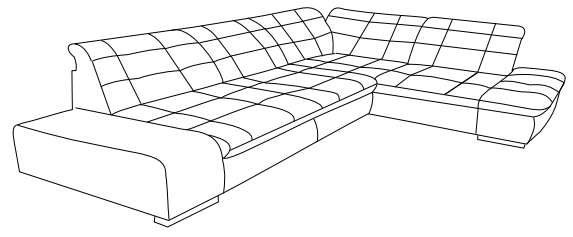
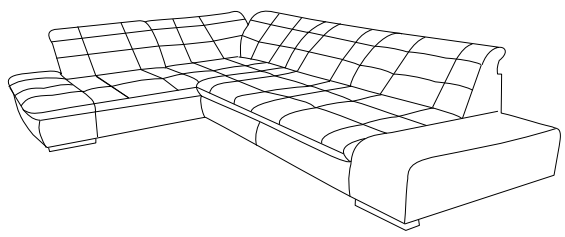

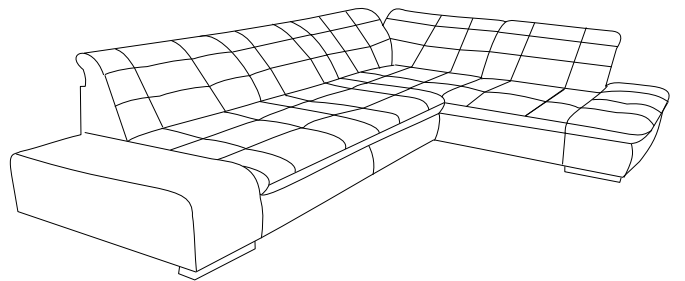
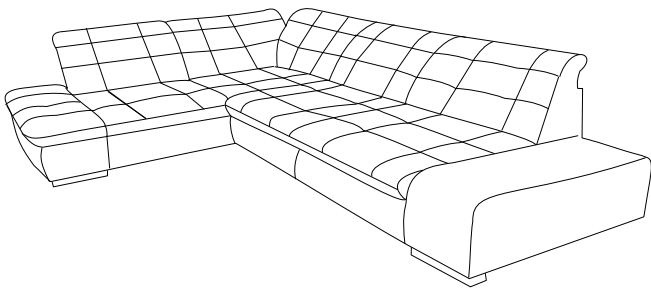
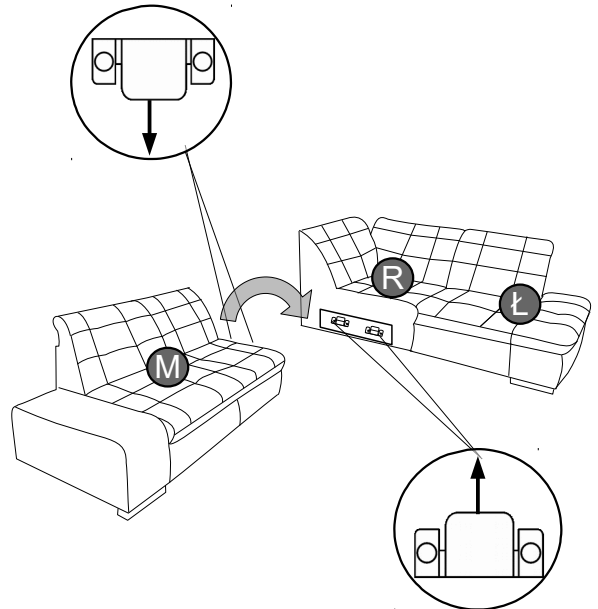
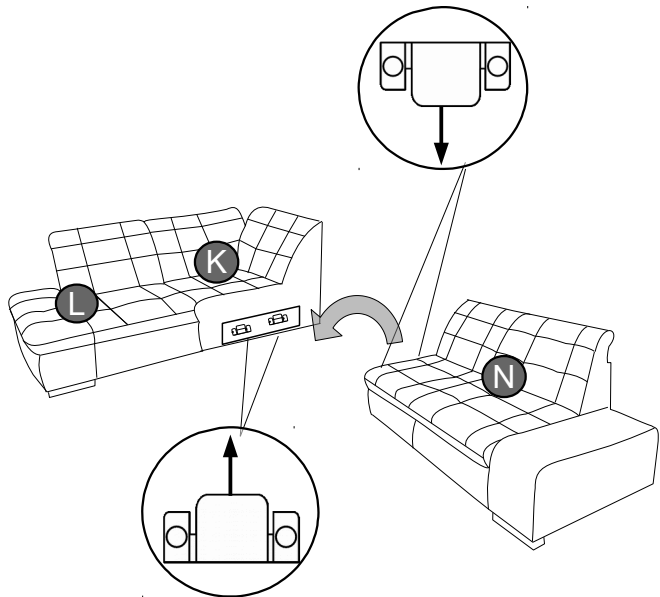
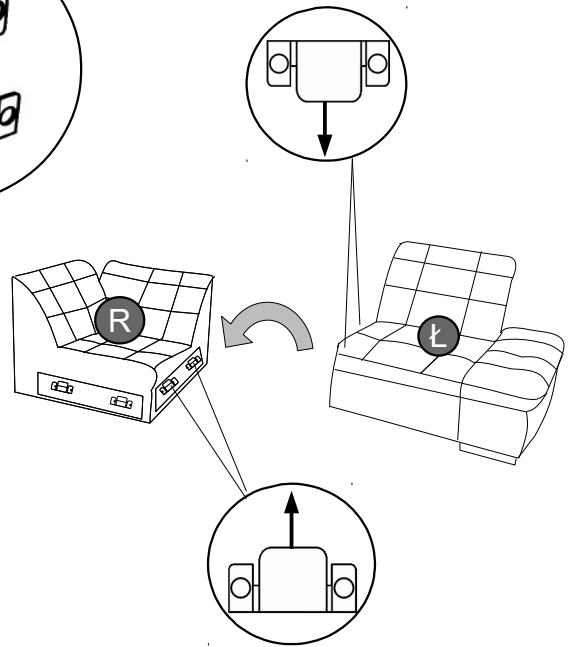
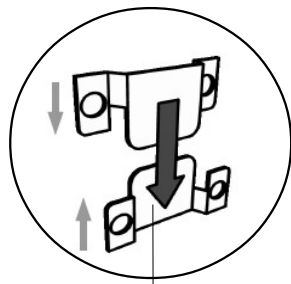
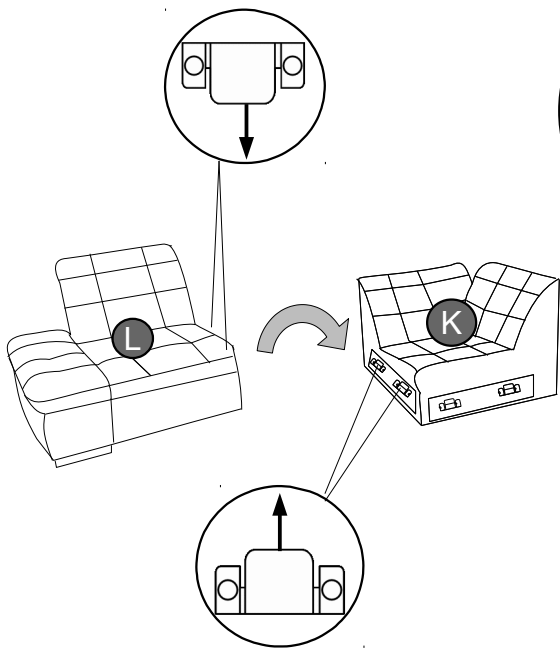

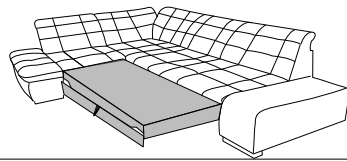
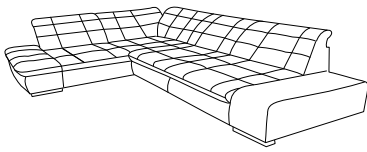

0019

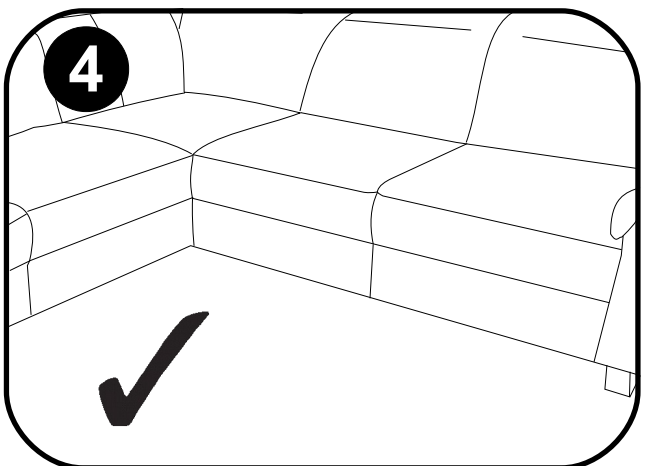
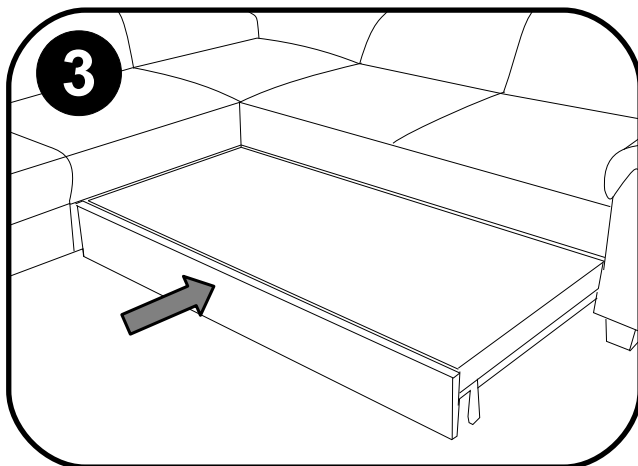
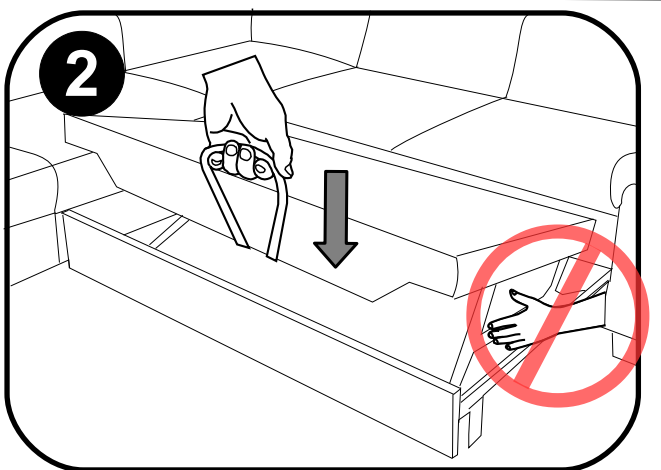
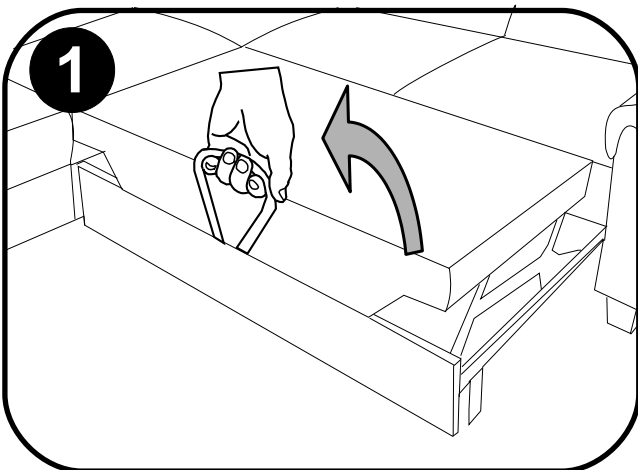
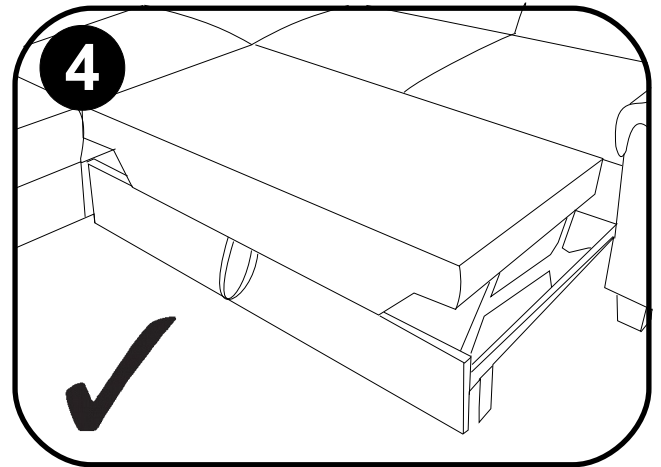
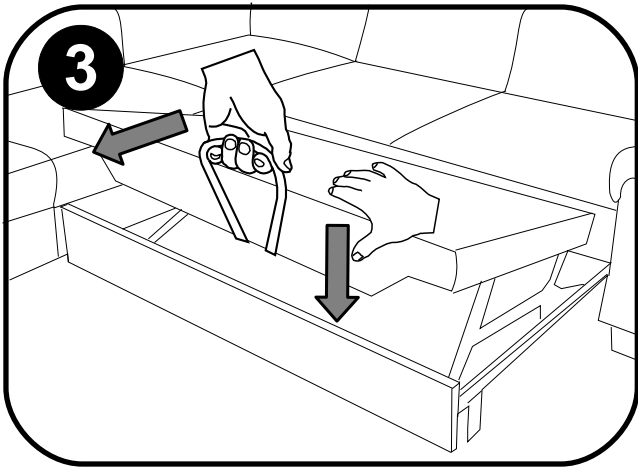
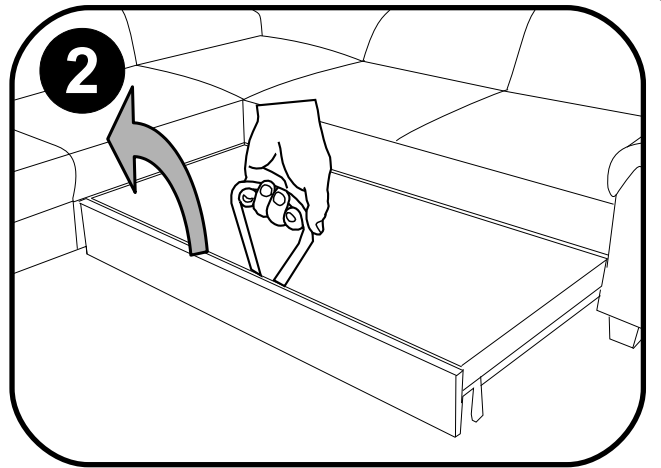
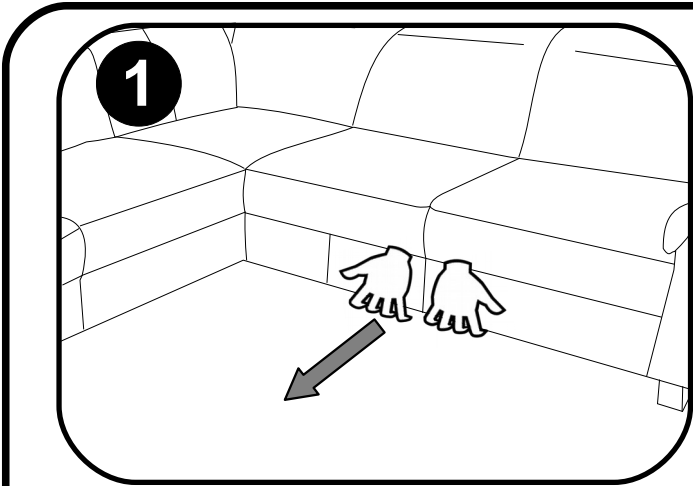

Service · Dienstverlening · Serwis · Servis · Сервисная служба · Serviciu · Services · Servizio
 · Servisný list · Szolgáltatás · Servisní list

Name · Naam · Nazwa · İsim · Название · Nume · Nome · Názov · Názov ·
 Název · Neve

PALE / PALOMINO

Typ · Type · Tip · Тип · Típo · Típus

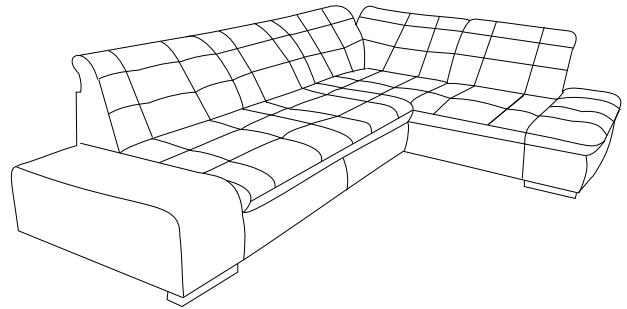
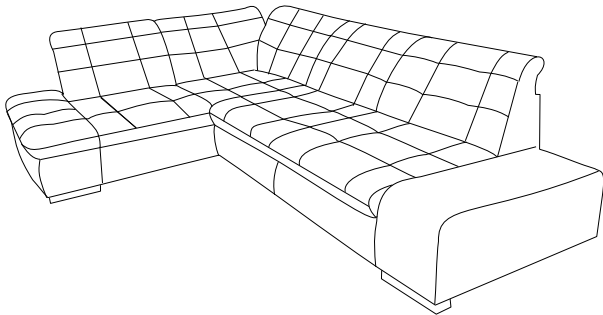
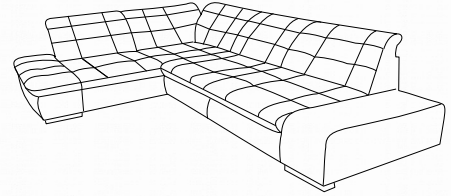
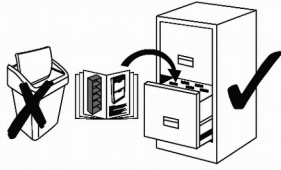

11
12
13
14

10

9

8

7

6

5





4

3

2

1

0

g H-50 	Z H-50 	y H-50 	x Fi-35 	d M5*50 [mm] 
--	--	--	---	--

