

# >> SCHIEBETUERENSCHRANK ARABESK <<

640016

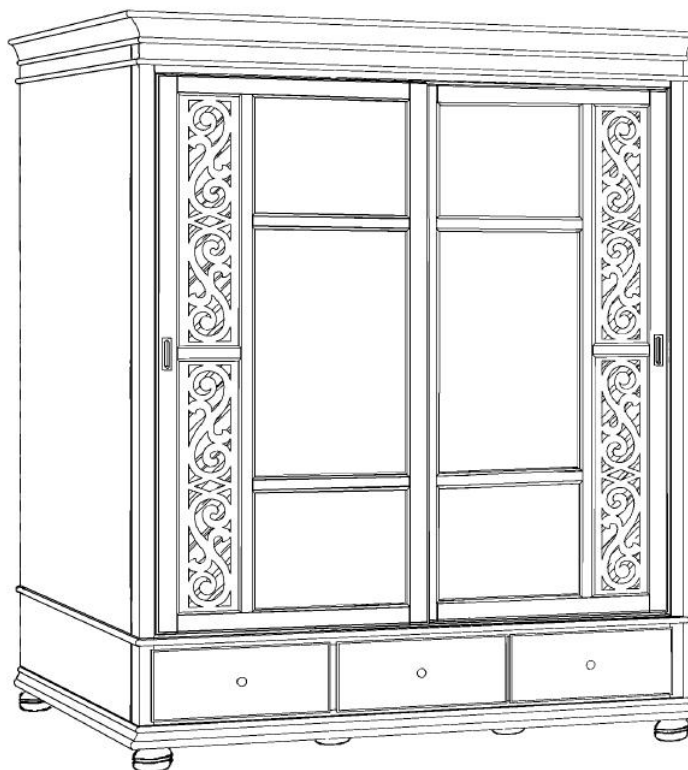

- |                           |                                  |                              |
|---------------------------|----------------------------------|------------------------------|
| (PL) Instrukcja montażu   | (F) Model d'emploi               | (RU) Инструкция по монтажу!  |
| (CZ) Návod k montáži      | (HU) Szerelési útmutató          | (RO) Instrucțiuni de montare |
| (D) Montageanleitung      | (I) Istruzione di montaggio      | (SK) Návod k montáži         |
| (GB) Assembly instruction | (NL) Handleiding voor de montage | (TR) Montaj talimatı         |

Creme

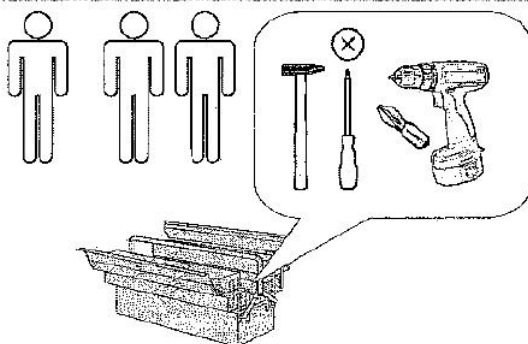

0  
10  
20  
30  
40  
50  
60  
70  
80  
90  
100  
110  
120  
130  
140  
150  
160  
170  
180  
190  
200

Karta serwisowa • Servisni list • Service Karte • Service card • Carte de service • Szervizkártya Scheda di servizio • Service kaart • Сервисная карта • Fisa service • Servisný list • Servis karti	
Name • Naam • Nazwa • Isim • Название <b>SCHIEBETUERENSCHRANK</b>	
Nr. • No. • Номер  Crème	
Тур • Туре • Тір • Тип  Crème	

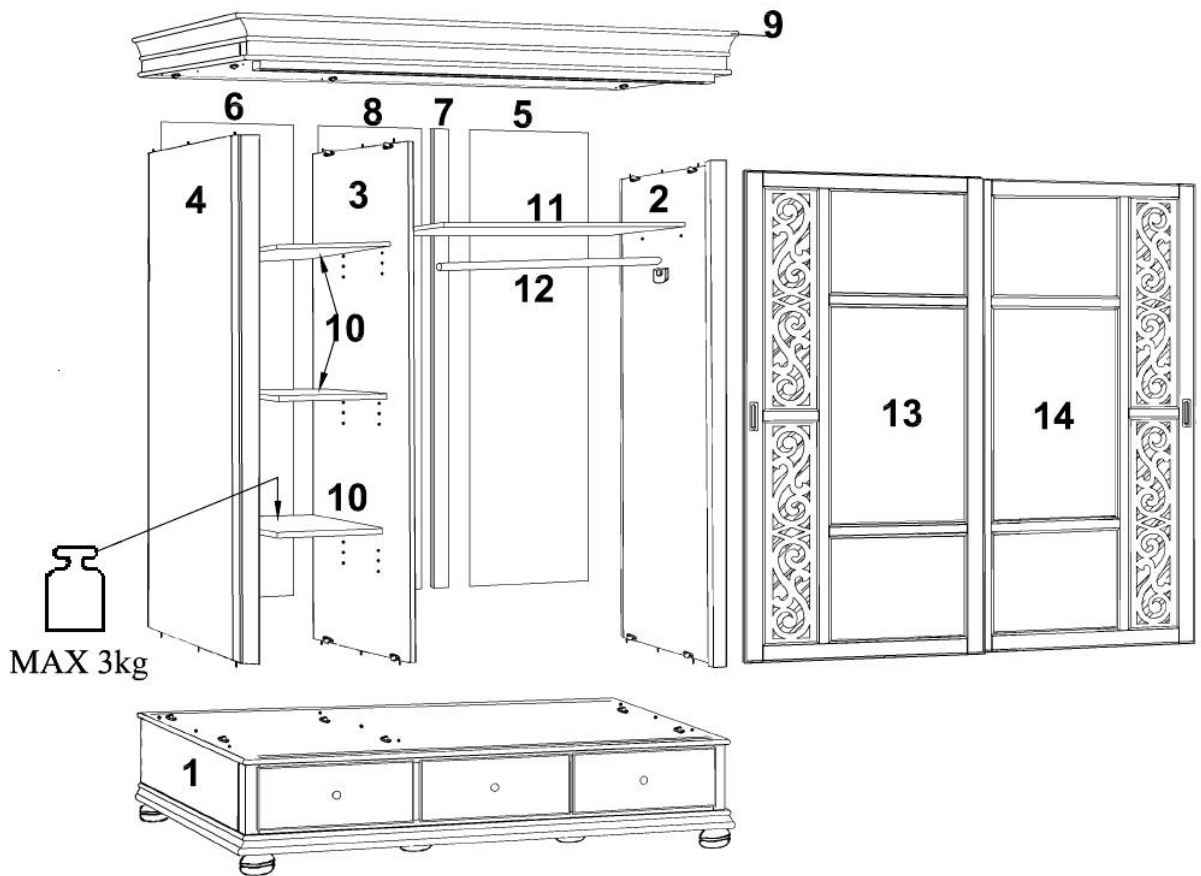

<b>A</b> 3.5 x 18 mm x 24	<b>B</b> x 6	<b>C</b> 3 x 16 mm x 18	<b>D</b> x 6
<b>E</b> 3.5 x 25 mm x 1	<b>F</b> x 16		

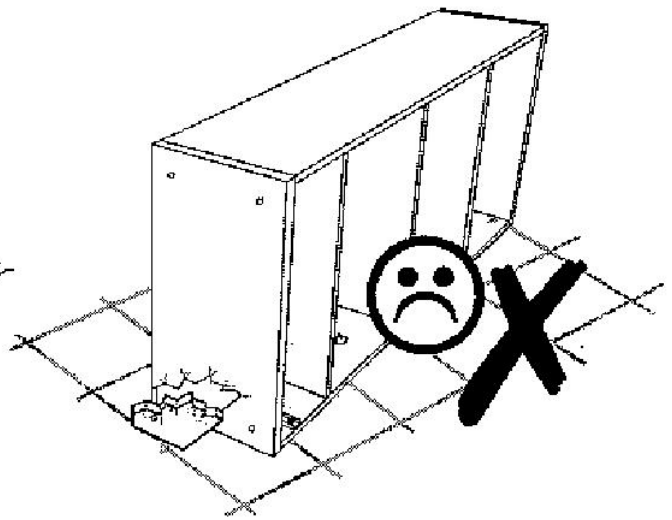
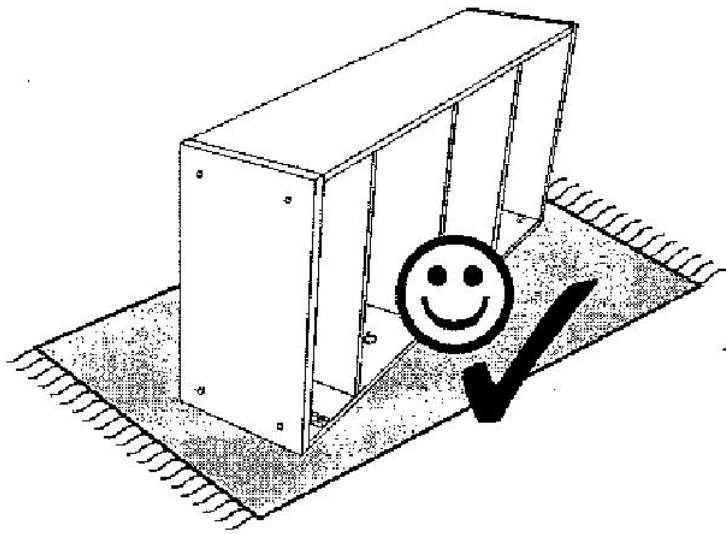

1.

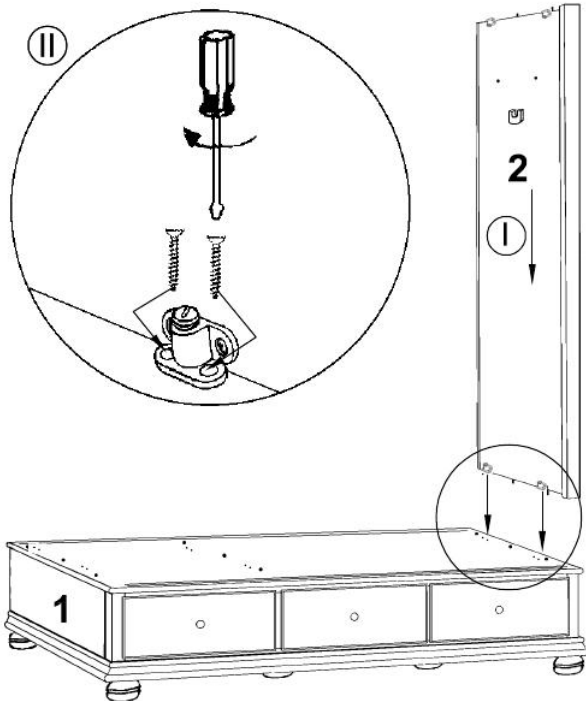

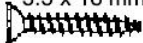
**A** 3.5 x 18 mm  x 4

2.

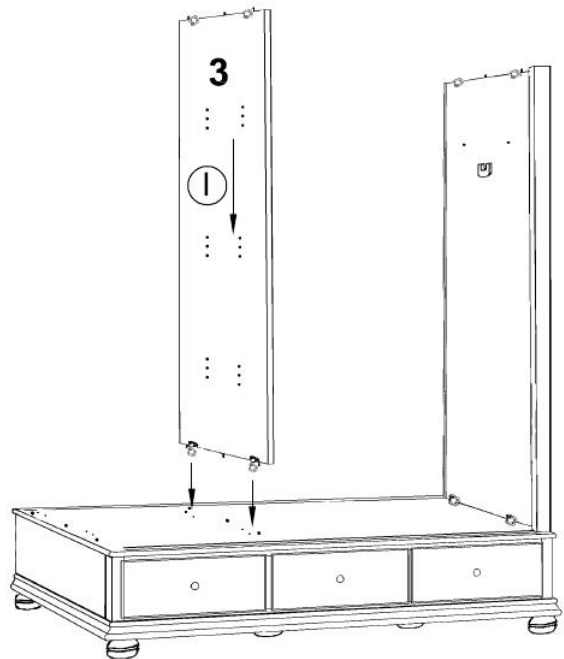

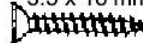
**A** 3.5 x 18 mm  x 4

3.

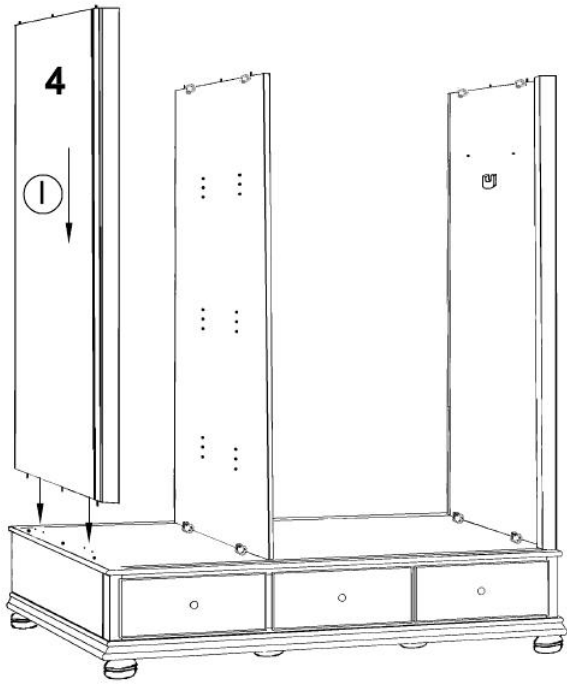

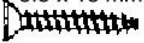
**A** 3.5 x 18 mm  
 x 4

4.

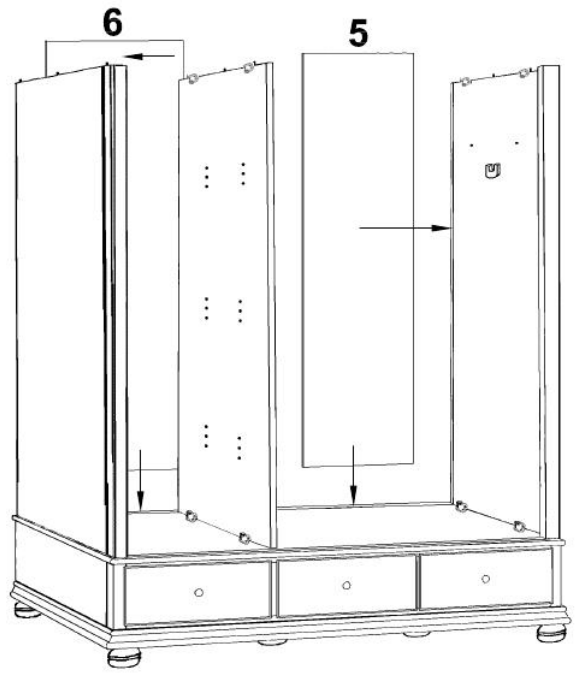

5.

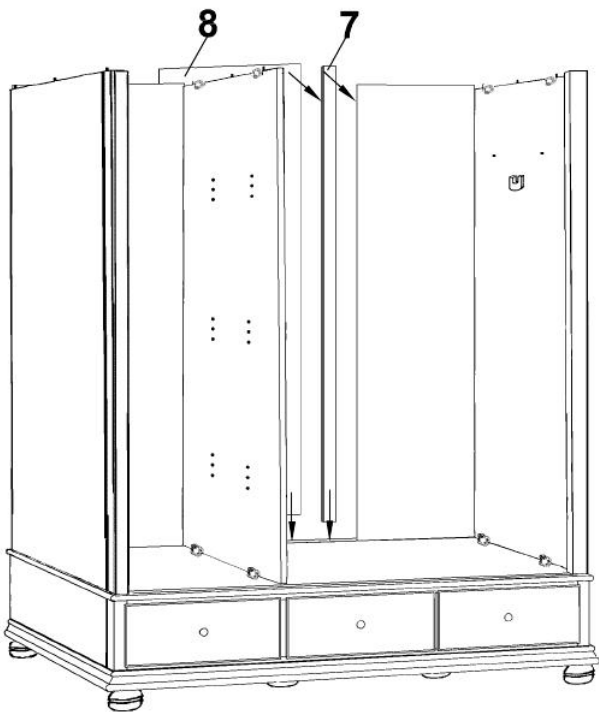

6.

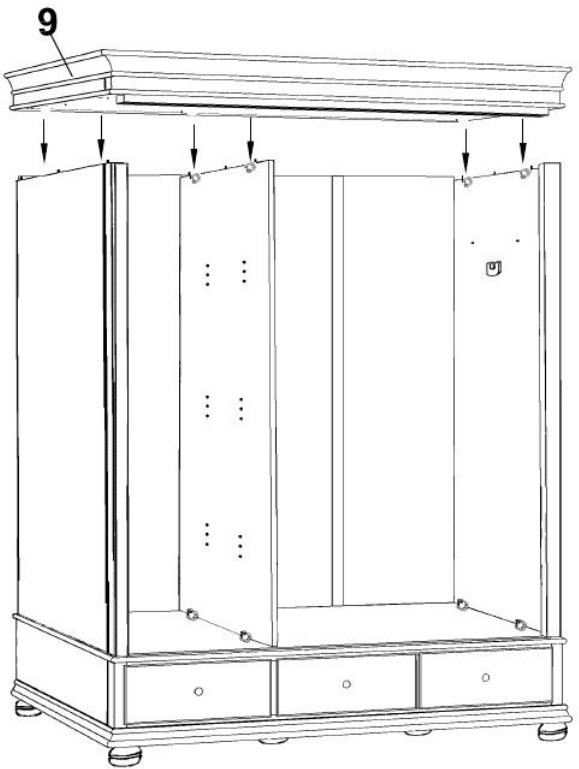

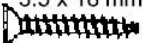

**A** 3.5 x 18 mm  
 x 12

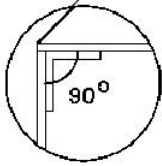
7.

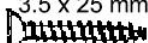

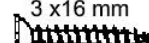
**E** 3.5 x 25 mm  
 x 1

**C** 3 x 16 mm  
 x 12

**D**  
 x 6

**B**  
 x 6

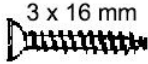
**C** 3 x 16 mm  
 x 6

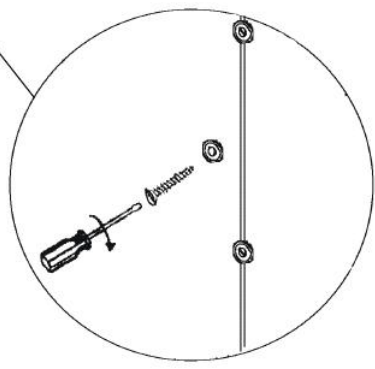
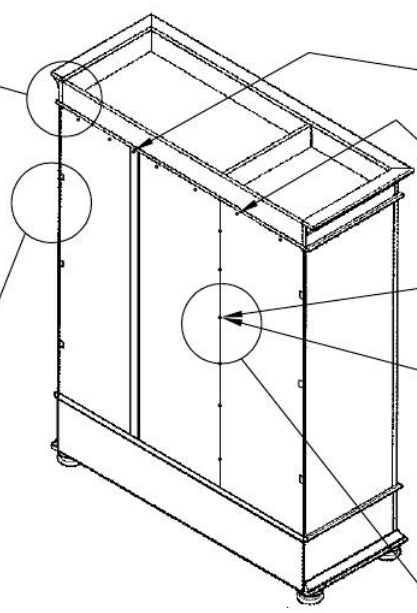
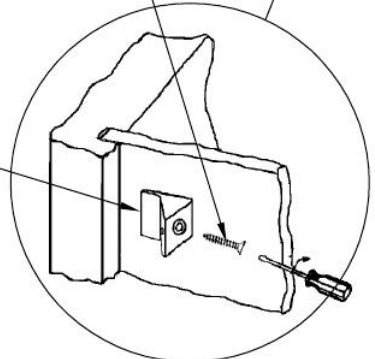

8.

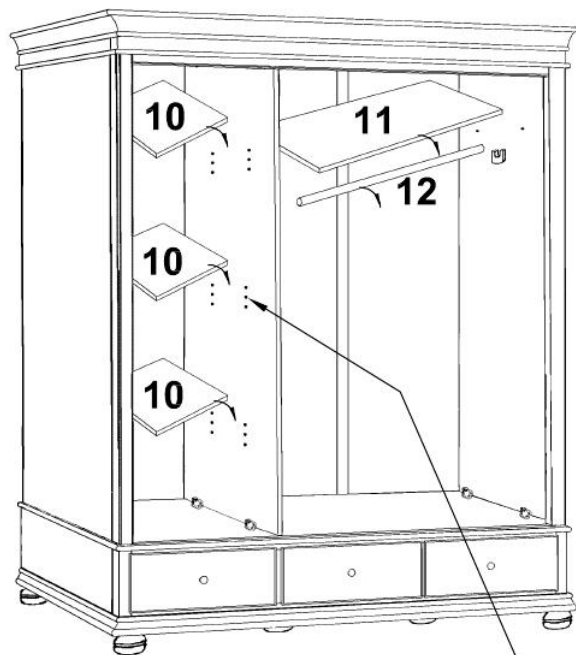

**F**  
 x 16

9a.

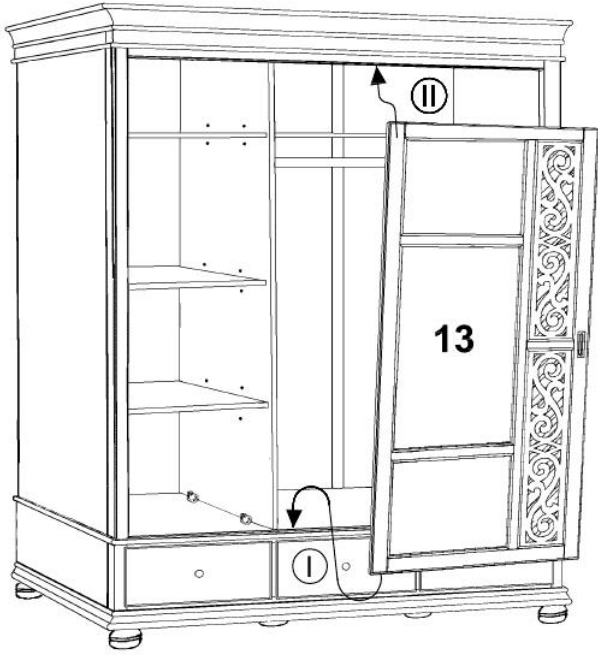

9b.

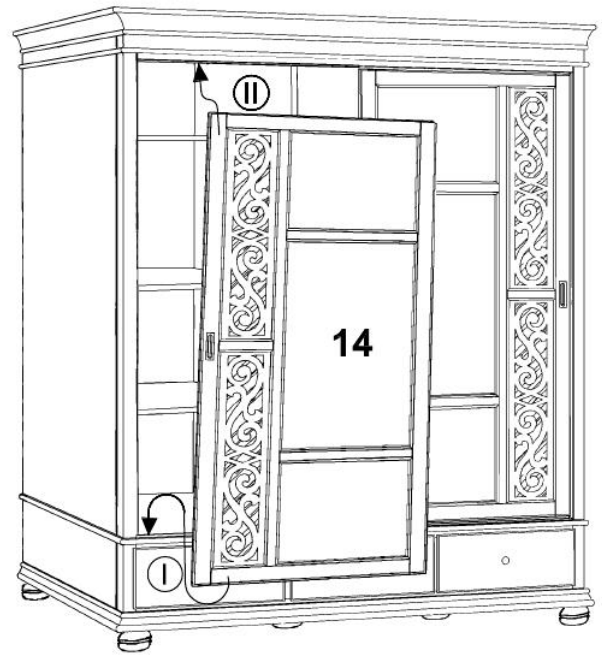

9c.

