

- | | | | |
|---------------------------------------|-----------------------------------|------------------------------|----------------------------------|
| D Montageanleitung | GB Assembly instructions | CZ Montážní návod | SK Návod na montáž |
| FR Notice de montage | IT Istruzioni di montaggio | HU Szerelési útmutató | RO Instrucțiuni de montaj |
| NL Handleiding voor de montage | PL Instrukcja montażu | TR Montaj talimatı | RU Инструкция по монтажу |

DUCON

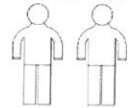

4 mm



PL Śruby należy przykręcać równomiernie.
D Schrauben sollten gleichmäßig angezogen werden.
FR Les vis doivent être serrées uniformément.
GB Screws should be tightened equally.
CZ Šrouby by měly být rovnoměrně utaženy.
SK Skrutky by mali byť rovnomerne dotiahnuté.
RU Винты должны быть затянуты равномерно.
RO Șuruburile trebuie strânse uniform.
HU A csavarokat egyenletesen kell meghúzni.
IT Le viti devono essere serrate uniformemente.
NL De schroeven moeten gelijkmatig worden vastgedraaid.
TR Vidalar eşit şekilde sıkılmalıdır.

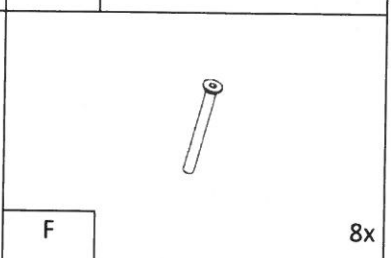
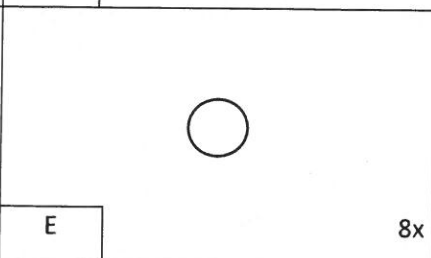
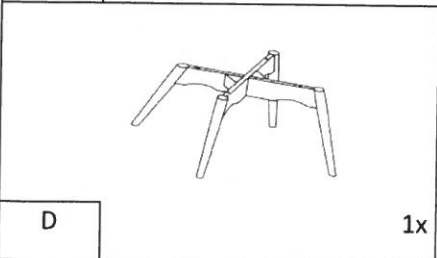
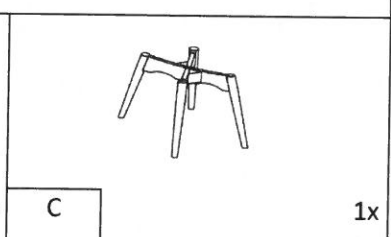
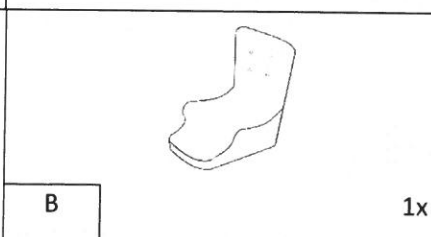
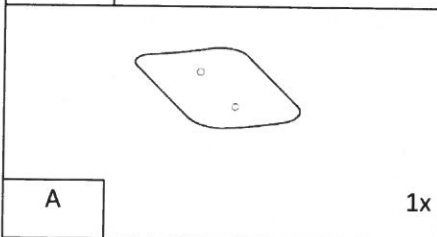
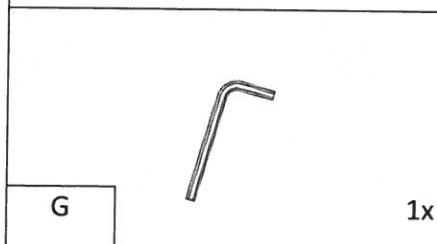
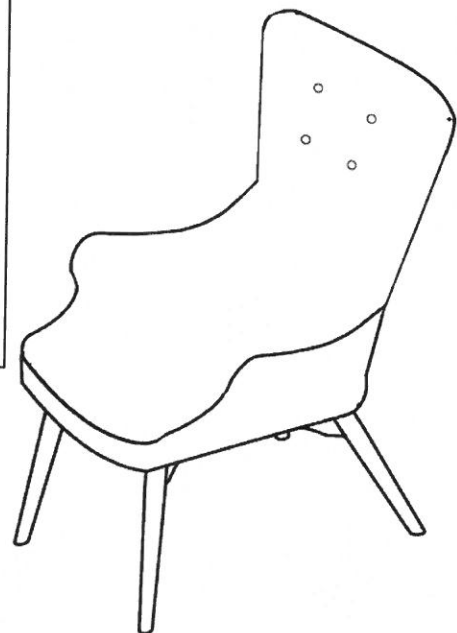

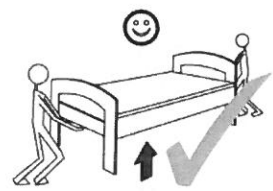
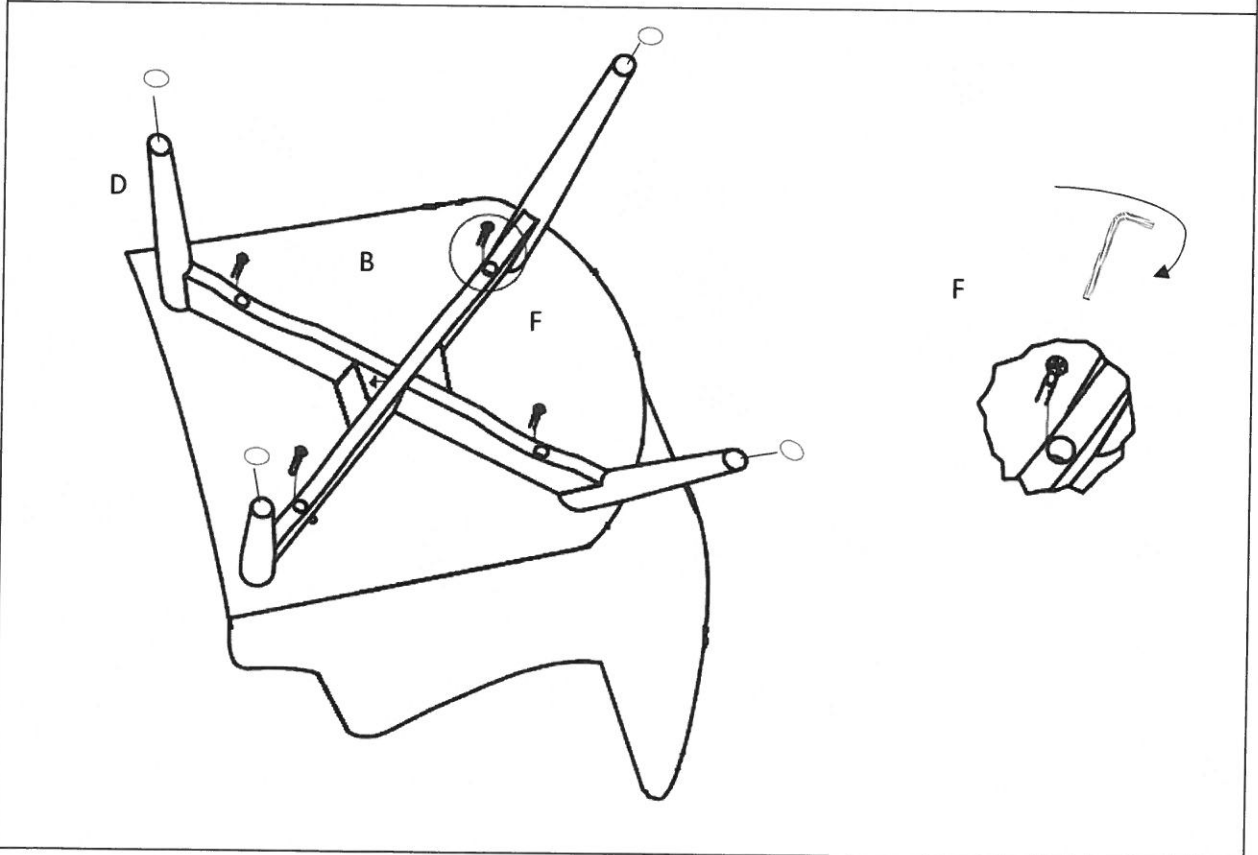
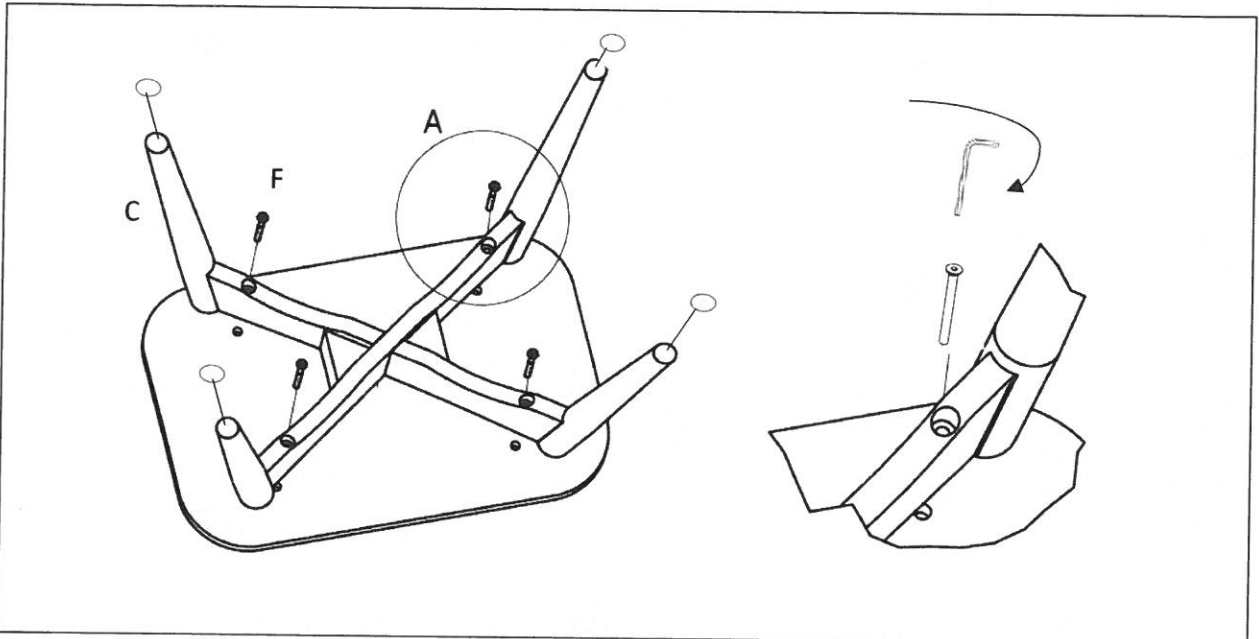

**Service • Assistenza • Dienstverlening • Serwis
Servis • Szerviz • Сервисная служба**

Name • Naam • Nazwa • İsim • Название





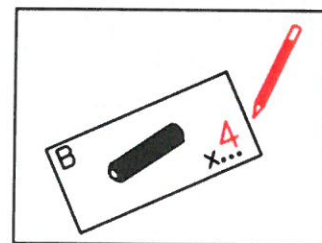
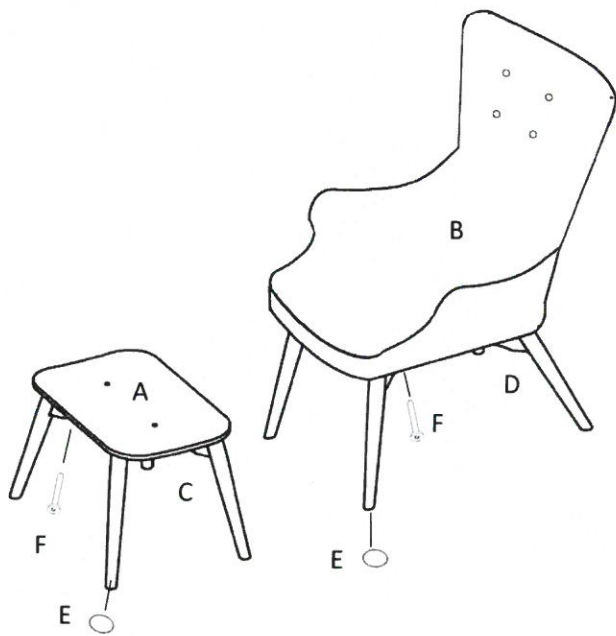
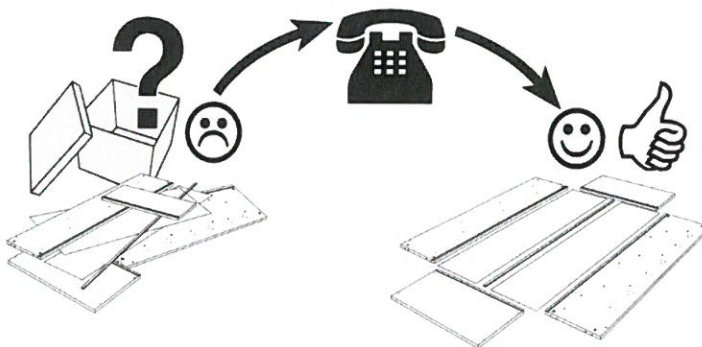
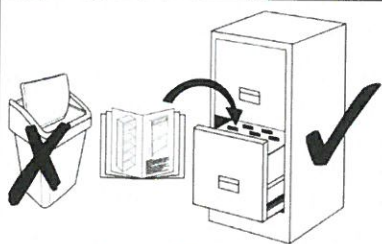

DUCON

Nr. • No. • Номер

Тур • Туре • Тип • Тип

1



| | | | |
|--------------------------------------------------------------------------------------|-------|---------------------------------------------------------------------------------------|-------|
|  | |  | |
| E | | F | |
|  | |  | |
| A | | B | |
|  | |  | |
| C | | D | |