

87174 87175 87176 88496 88497

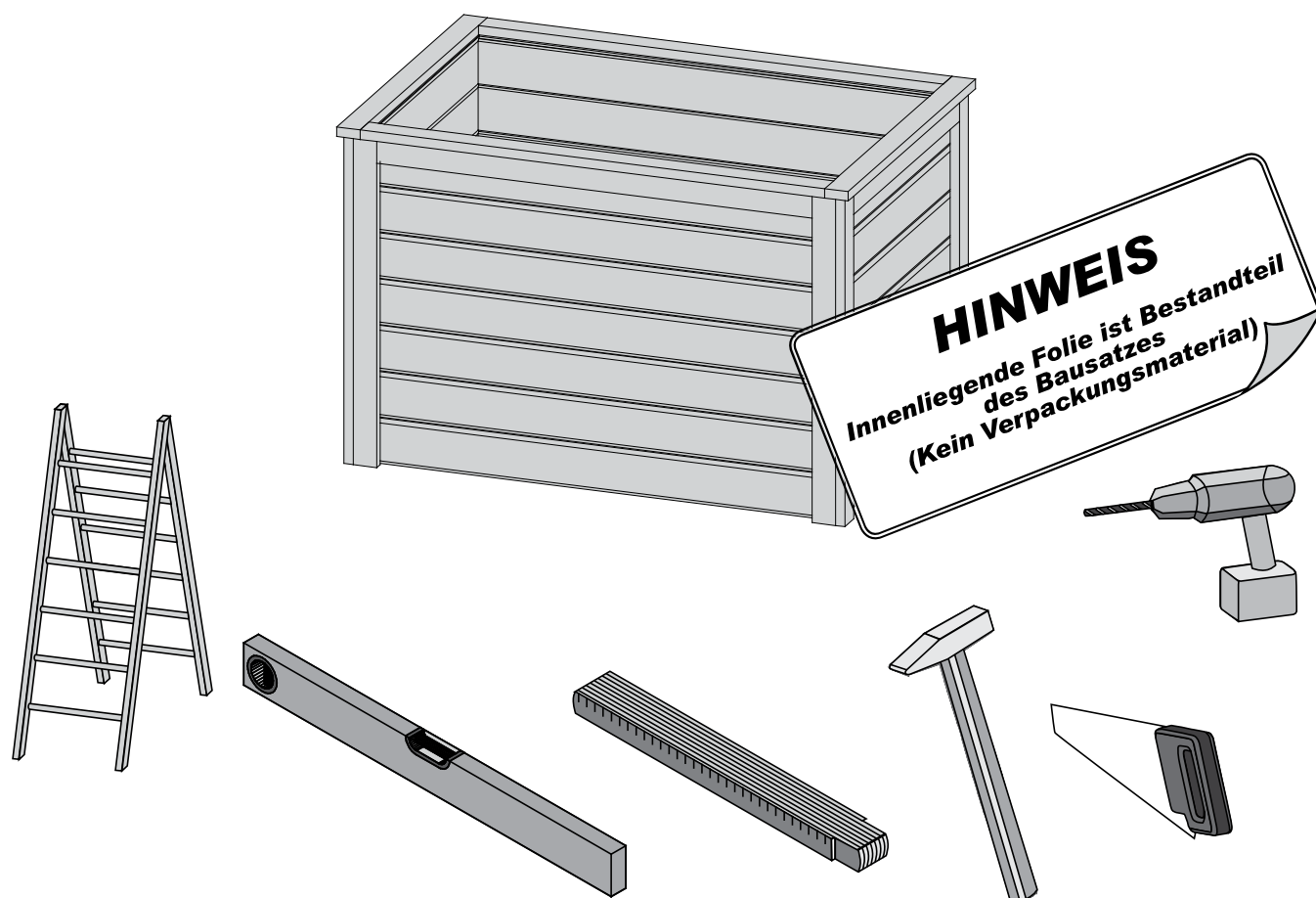

 **Aufbauanleitung**

 **Building Instructions**

 **notice de montage**

 **montagehandleiding**

 **Montagevejledning**

 **Instrucciones de construcción**

 **Istruzioni per il montaggio**

 **Montážní návod**



+49 421 38693 33



Vergleichen Sie zuerst die Material-liste mit Ihrem Paketinhalt! Bitte haben Sie Verständnis, dass Beanstandungen nur im nicht aufgebauten Zustand bearbeitet werden können!



Vergelijk eerst de lijst van materialen met de inhoud van uw pakket! Reclamaties kunnen alleen in behandeling worden genomen zolang de onderdelen nog niet zijn gemonteerd!



Confrontate questa distinta materiali prima con il contenuto del pacchetto! Vi preghiamo di comprendere che eventuali reclami possono essere accolti solo prima del montaggio!



First compare the list of materials with your package contents! Please understand that complaints can be processed in the non-built status only!



Start med at kontrollere materialelisten med indholdet af den leverede pakke! Vi gør venligst opmærksom på at reklamationer kun kan behandles for materialer som ikke er blevet bearbejdet!



Nejprve přezkontrolujte obsah balení podle materiálového listu! Mějte pochopení pro to, že případnou reklamaci se můžeme zabývat pouze tehdy, když díly nebudou smontované! Za pomoci tohoto seznamu můžete jednotlivé díly přiřadit k montážnímu návodu.



Commencez par comparer la liste du matériel avec le contenu de votre paquet! Sachez que nous traitons uniquement les réclamations concernant le matériel à l'état non monté!



En primer lugar, compare la lista de material con el contenido del paquete. Rogamos entienda que las reclamaciones sólo pueden ser tramitadas antes de montar el objeto!

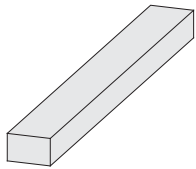
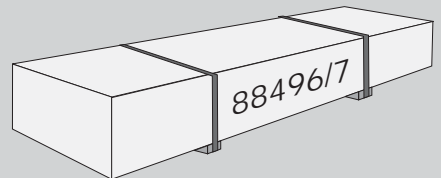
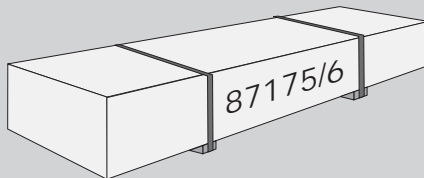
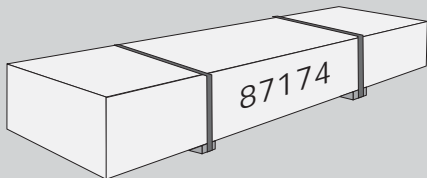

4 x B1	645 x 45 x 18 mm	ID 63865
8 x B2	624 x 45 x 18 mm	ID 87177
4 x B3	890 x 45 x 18 mm	ID 16422

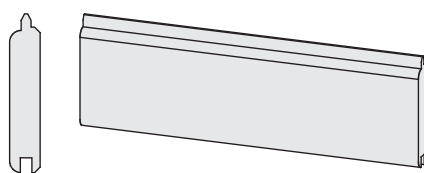

14 x R1	590 x 96 x 19 mm	ID 25597
14 x R2	890 x 96 x 19 mm	ID 34114



1 x		ID 65384
-----	--	----------

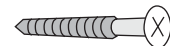

180 x	4 x 35 mm	ID 3687
40 x	4 x 50 mm	ID 3688

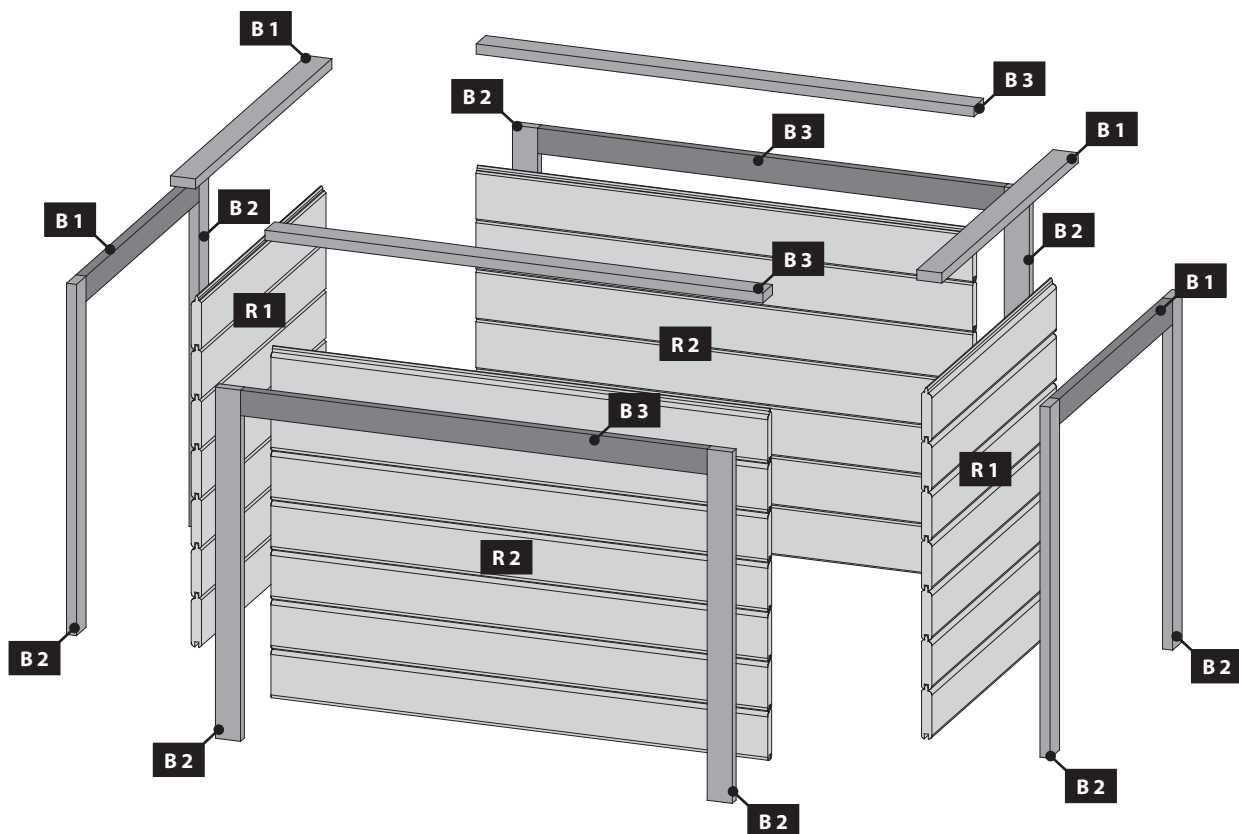

Ø3mm 4x35

112x

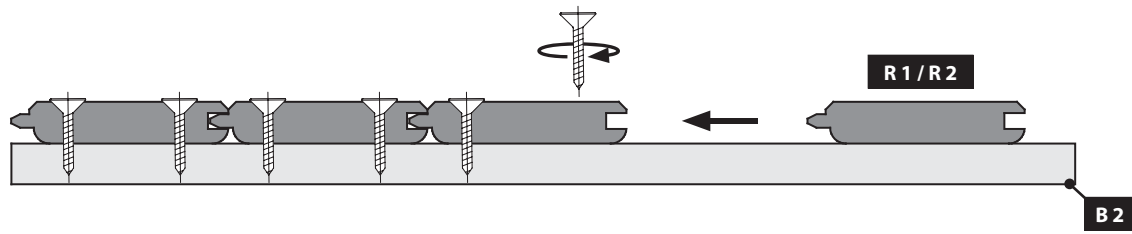
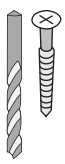

01

2x

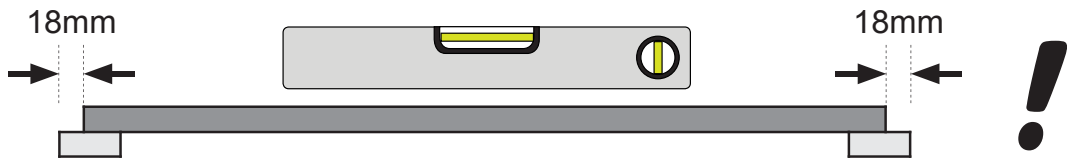
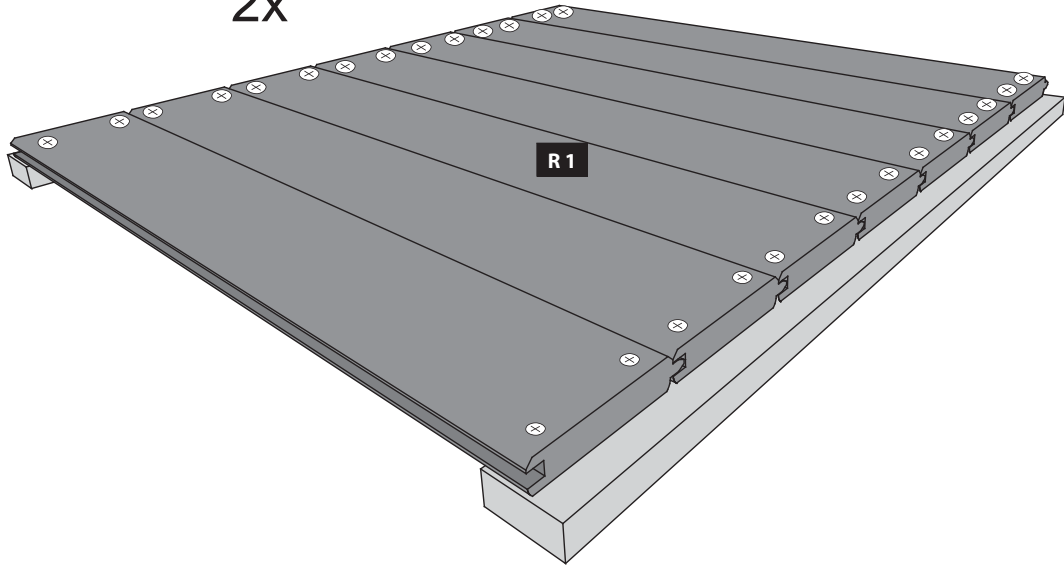

2x

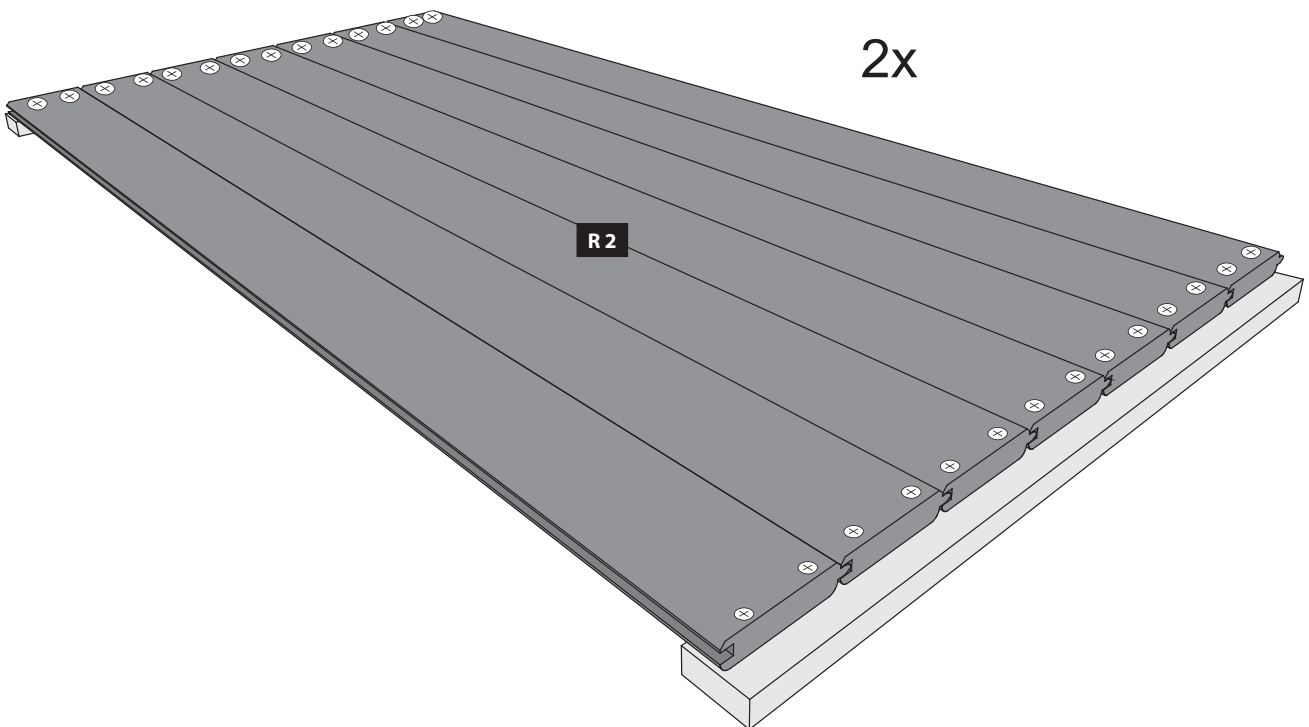

Ø3mm 4x50

20x

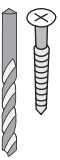

-  Bündig!
-  Flush!
-  Affleurement!
-  Gelijk!
-  I flugt!
-  Aras!
-  Combacia!
-  Stejný !

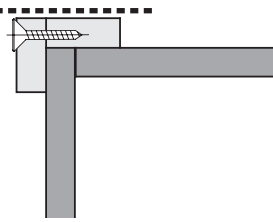

02

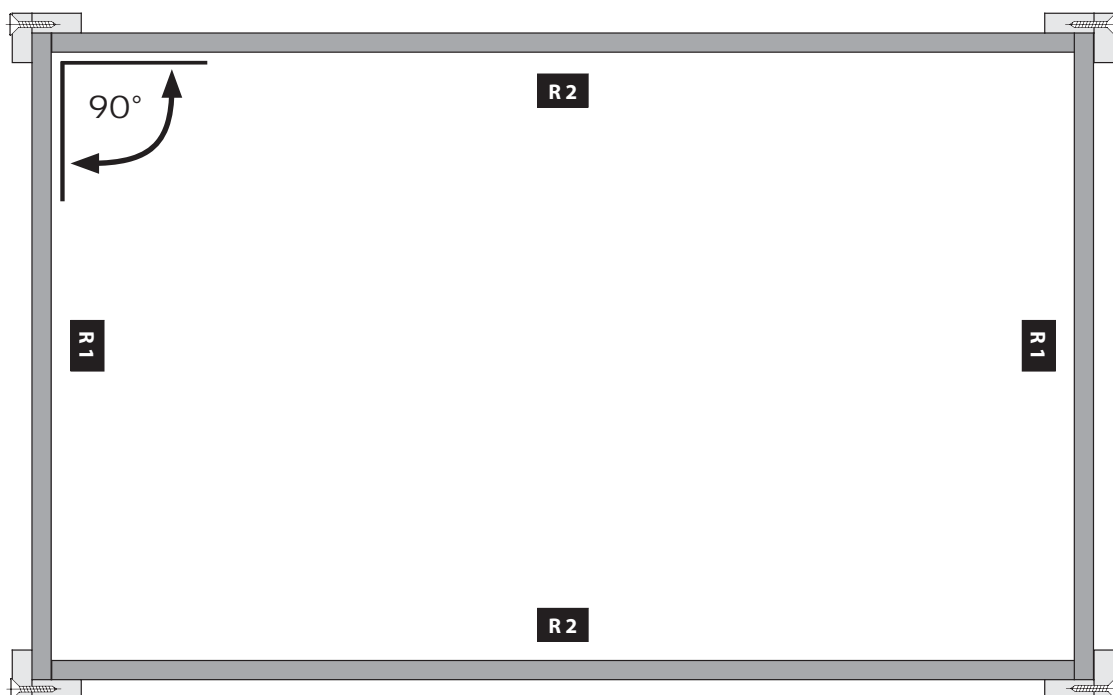
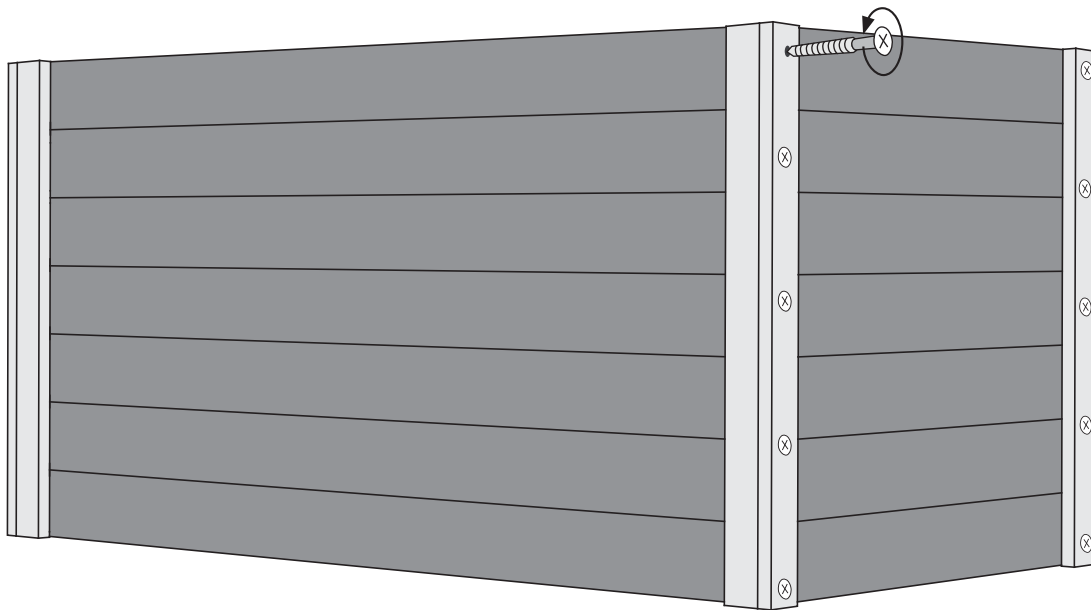

18x

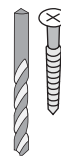



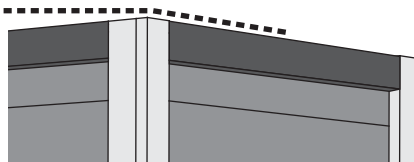

-  Bündig!
-  Flush!
-  Affleurement!
-  Gelijk!
-  I flugt!
-  Aras!
-  Combacia!
-  Stejný !

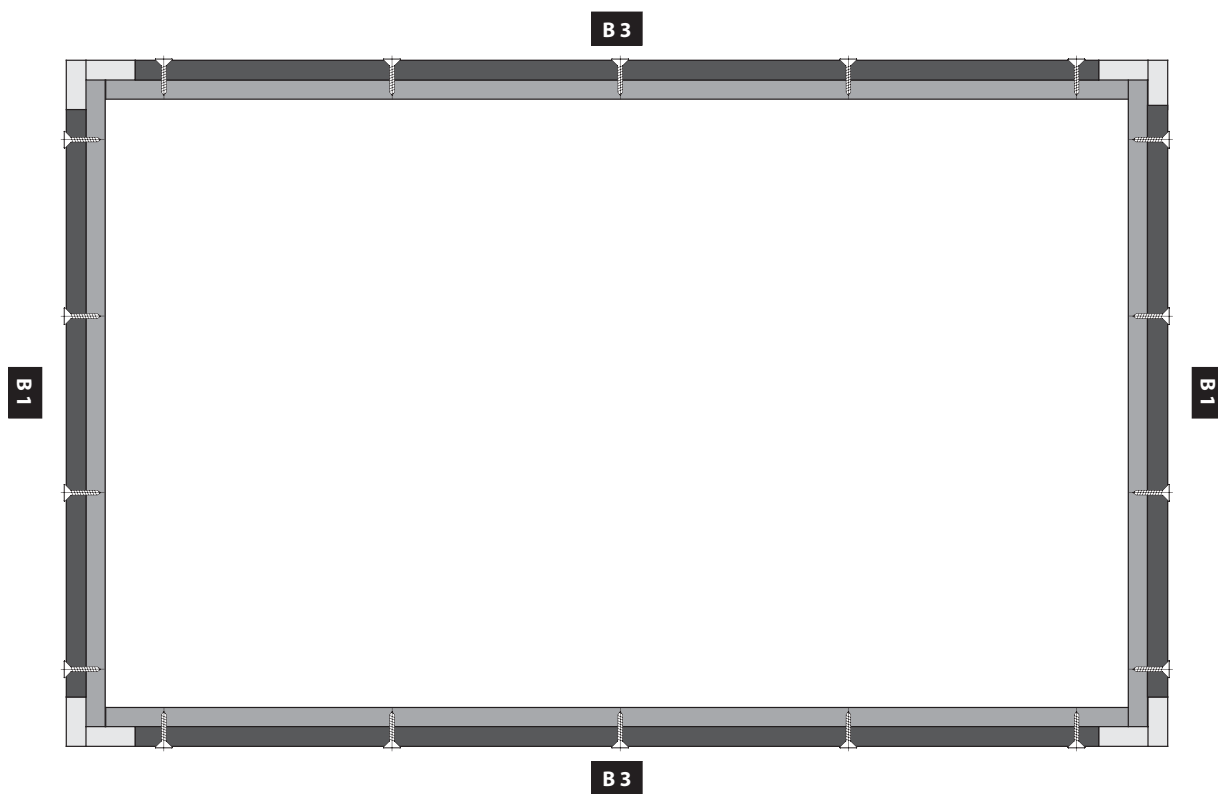
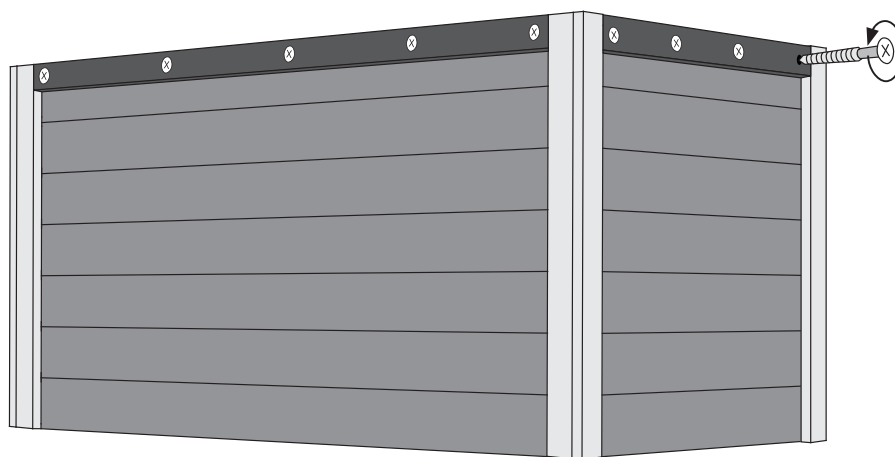
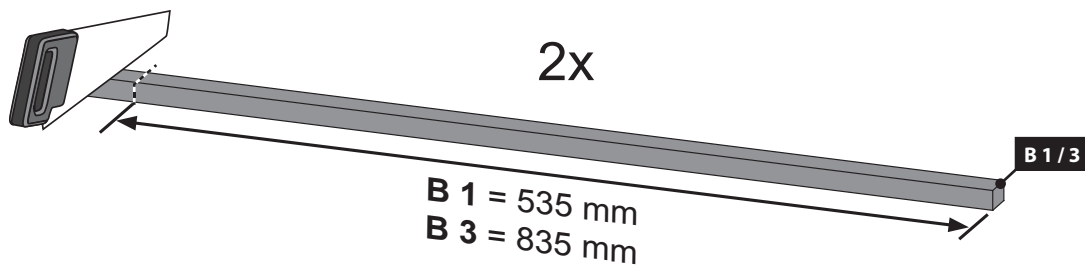





03



*

 Nicht im Lieferumfang enthalten
 Not included
 Non comprises dans la livraison
 Niet bijgeleverd

 No forman parte del suministro
 Non incluso
 V ceně není zahrnuto
 Ikke inkluderet



04

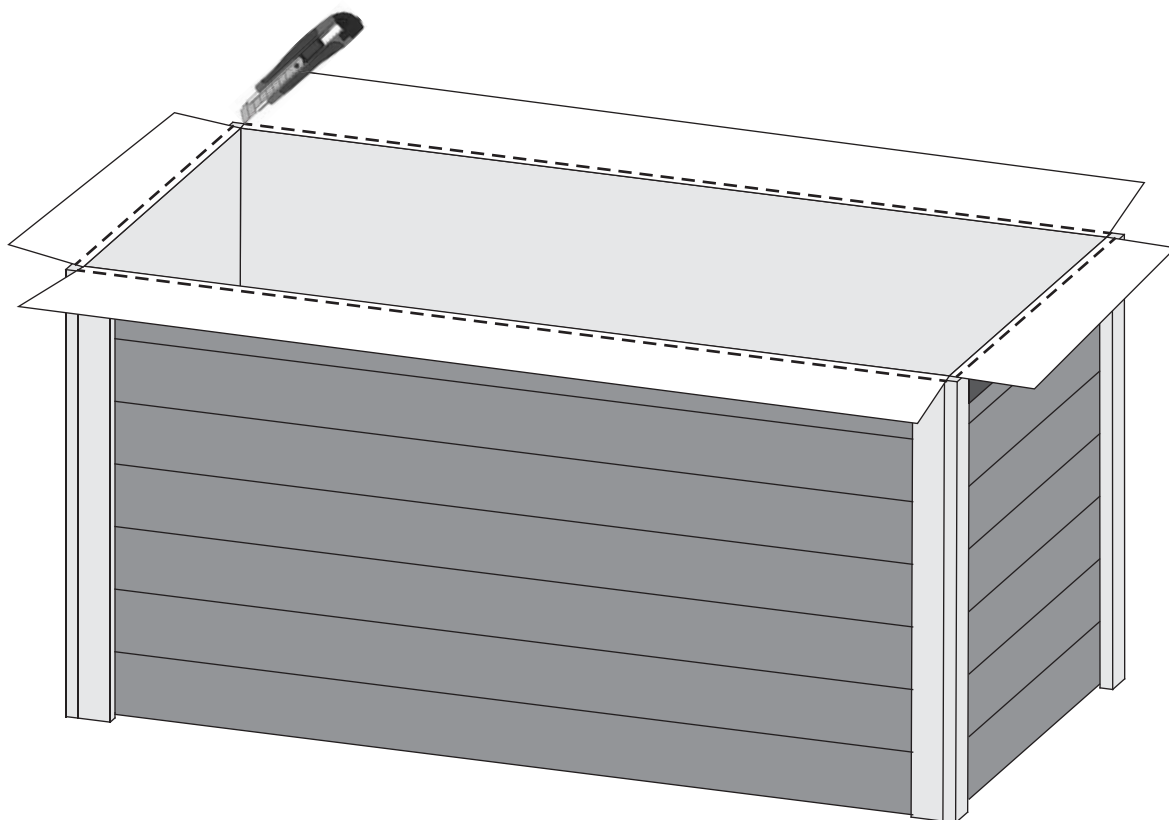

18x

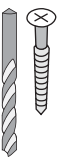



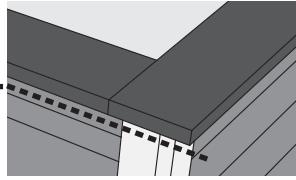

-  Bündig!
-  Flush!
-  Affleurement!
-  Gelijk!
-  I flugt!
-  Aras!
-  Combacia!
-  Stejný !

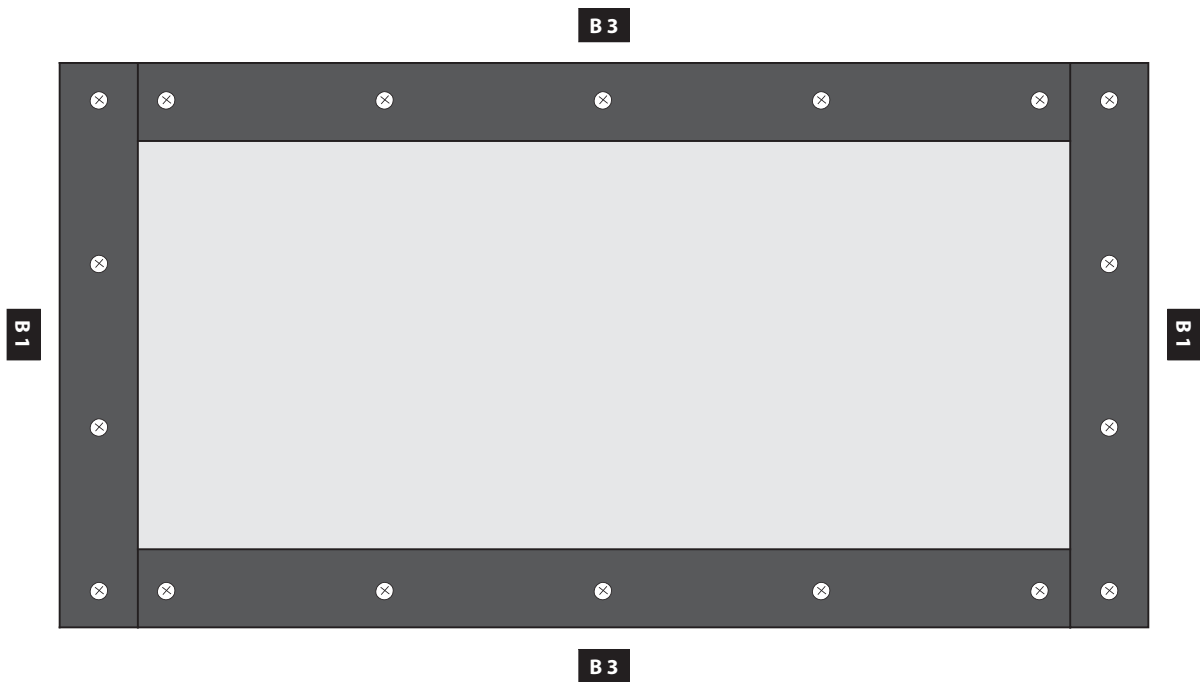
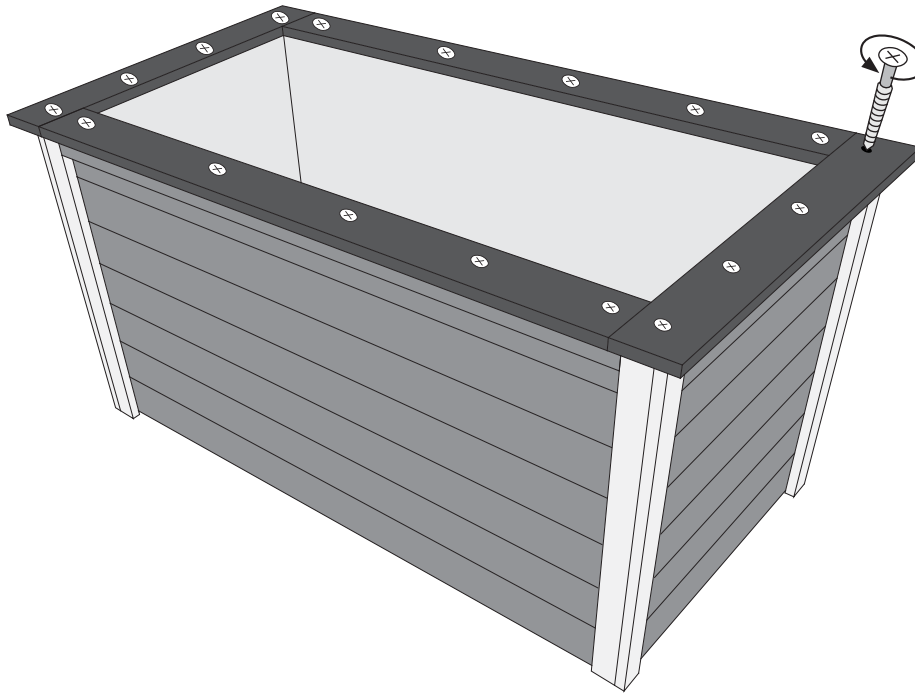



05



 Hochbeet befüllen
 remplir correctement
 fill properly

 goed invullen
 llenar correctamente

 riempire correttamente
 správně vyplňte

- A** Gartenerde / Kompost
- B** Laub / Grünschnitt
- C** Gehölzschnitt fein
- D** Grobe Äste / Zweige

