

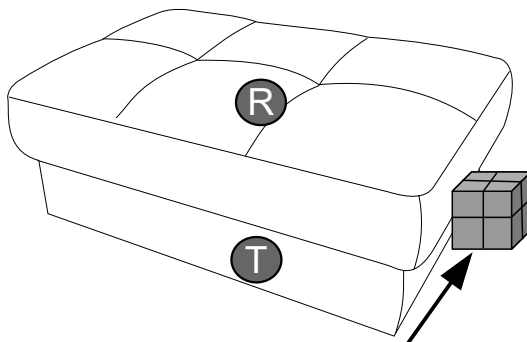



MAGGIORE
6030-0088

B

220701

- | | | | |
|-----------|--|-----------|---|
| D | MONTAGEANLEITUNG BEDIENUNGSANLEITUNG | GB | ASSEMBLY INSTRUCTIONS INSTRUCTION MANUAL |
| NL | HANDLEIDING VOOR DE MONTAGE GEBRUIKSAANWIJZING | PL | INSTRUKCJA MONTAŻU INSTRUKCJA OBSŁUGI |
| TR | MONTAJ TALIMATI KULLANIM KLAVUZU | RU | ИНСТРУКЦИЯ ПО МОНТАЖУ ИНСТРУКЦИЯ ПО ЭКСПЛУАТАЦИИ |
| RO | INSTRUCȚIUNI DE INSTALARE INSTRUCȚIUNI DE UTILIZARE | IT | ISTRUZIONI DI MONTAGGIO MANUALE DI ISTRUZIONI |
| FR | NOTICE DE MONTAGE MANUEL INSTRUCTIONS | SK | MONTÁŽNY NÁVOD NÁVOD NA POUŽITIE |
| HU | KÖZGYŰLÉS UTASÍTÁSOK KEZELÉSI UTASÍTÁS | CZ | MONTÁŽNÍ NÁVOD NÁVOD K POUŽITÍ |
| SI | NAVODILA ZA MONTAŽO NAVODILA ZA UPORABO | PT | INSTRUÇÕES DE MONTAGEM MANUAL DO USUÁRIO |
| ES | INSTRUCCIONES DE MONTAJE MANUAL DEL USUARIO | HR | UPUTE ZA MONTAŽU UPUTE ZA UPOTREBU |



| | | | |
|---|---|--|------|
| i L-5  | X H-120  X₁  | q M8*20  | [mm] |
| X1 | X4 | X4 | |

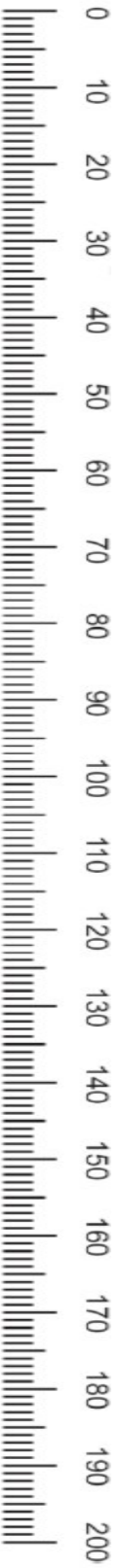
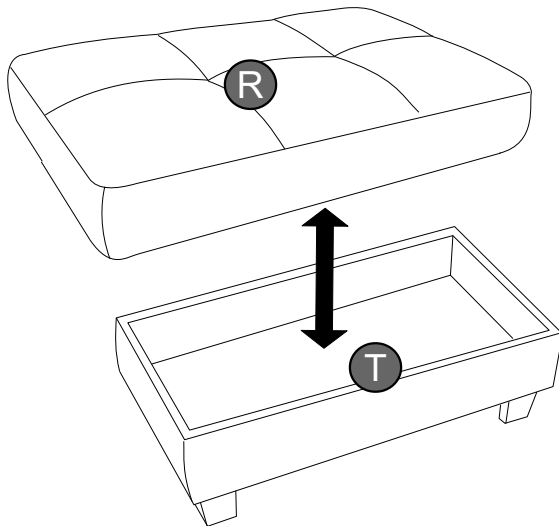
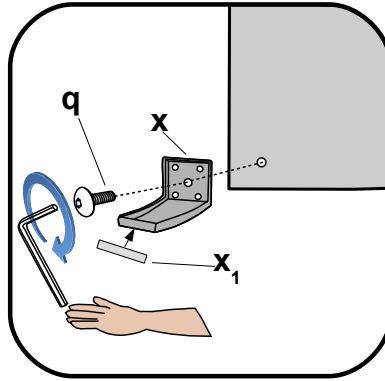
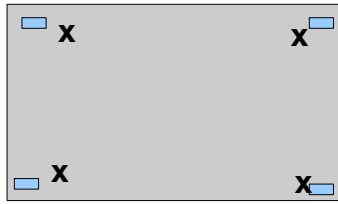



Name · Naam · Nazwa · Ísim · Название · Nume · Nome · Název · Názov ·
 Název · Neve

MAGGIORE

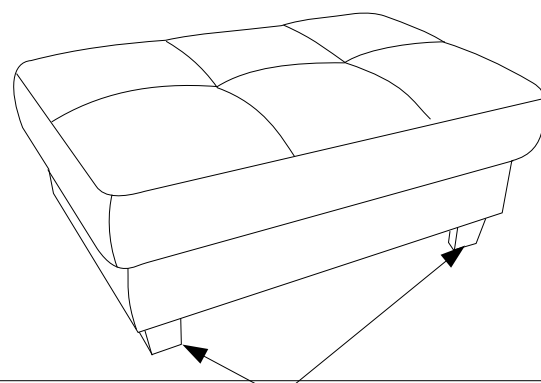
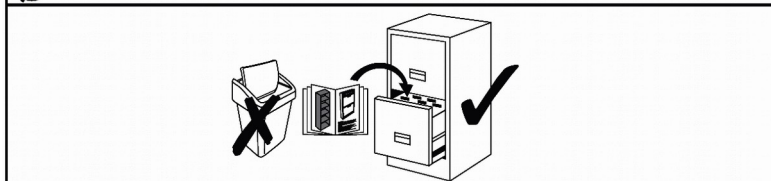
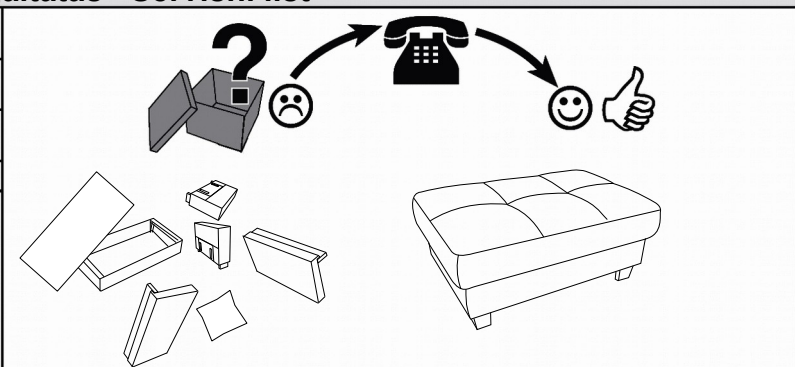
Typ · Type · Tip · Тип · Tipo · Típus



| | |
|--|---|
| x H- 120  x 1 | q M8*20 [mm]  |
|--|---|

