

- (D) Montageanleitung
- (NL) Handleiding voor de montage
- (HU) Szerelési útmutató
- (GB) Assembly instructions

- (PL) Instrukcja montażu
- (RO) Instrucțiuni de montaj
- (FR) Notice de montage
- (CZ) Montážní návod
- (TR) Montaj talimatı
- (IT) Istruzioni di montaggio
- (SK) Návod na montáž
- (RU) Инструкция по монтажу

**Service • Assistenza • Dienstverlening • Serwis  
Servis • Szerviz • Сервисная служба**

Name • Nom • Nome • Naam • Nazwa • Jméno • Názov • Név • Denimire • Isim • Название	
Nr. • No. • N° • Номер • Č • Sz	
Typ • Type • Tip • Tipus • Тиро • Тип	
	
	

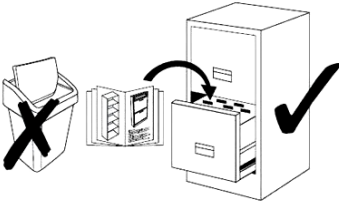
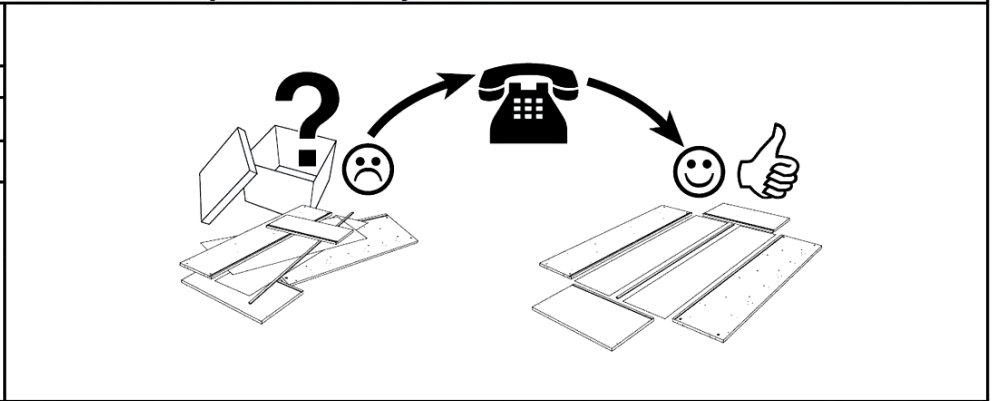









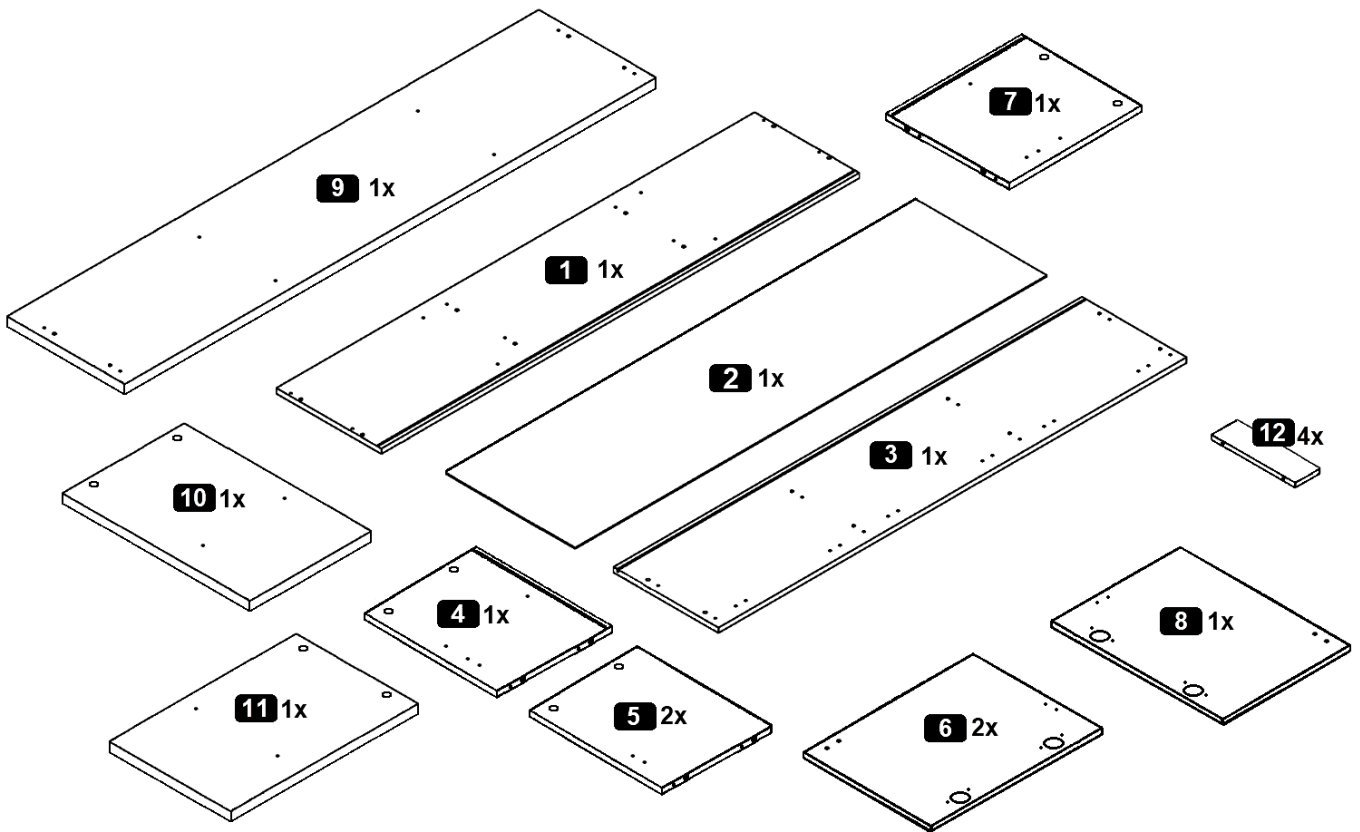







<b>1</b>	1x	ca. 1385 x 330 mm
<b>2</b>	1x	ca. 1366 x 330 mm
<b>3</b>	1x	ca. 1385 x 330 mm
<b>4</b>	1x	ca. 318 x 330 mm

<b>5</b>	2x	ca. 318 x 315 mm
<b>6</b>	2x	ca. 459 x 348 mm
<b>7</b>	1x	ca. 318 x 330 mm
<b>8</b>	1x	ca. 459 x 348 mm





<b>9</b>	1x	ca. 1583 x 350 mm
<b>10</b>	1x	ca. 443 x 350 mm
<b>11</b>	1x	ca. 443 x 350 mm
<b>12</b>	4x	ca. 310 x 80 mm

**1 ≠ 3**



<b>A</b> 8,0 x 30 mm  <b>28x</b>	<b>B</b>  <b>12x</b>	<b>C</b>  <b>12x</b>	<b>D</b>  <b>3x</b>	<b>E</b> 4,0 x 13 mm  <b>6x</b>	<b>F</b>  <b>6x</b>	<b>G</b> 4,0 x 20 mm  <b>6x</b>
<b>H</b> Ø35 Kr.0  3,5x13 mm <b>6x</b>	<b>I</b> h=2  <b>6x</b>	<b>J</b>  <b>4x</b>	<b>K</b> 2,7 x 20 mm  <b>4x</b>	<b>L</b> 200 mm  <b>3x</b>	<b>M</b> 3,5 x 13 mm  <b>18x</b>	<b>N</b>  <b>1x</b>
<b>O</b> 5,0 x 50 mm  <b>16x</b>						



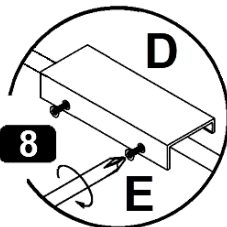
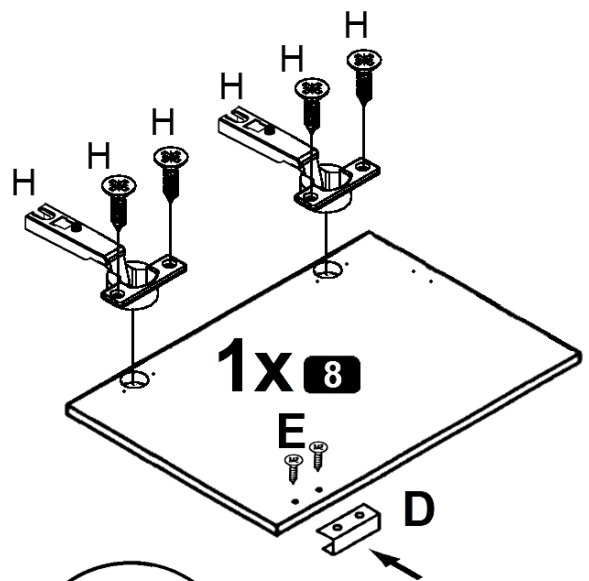
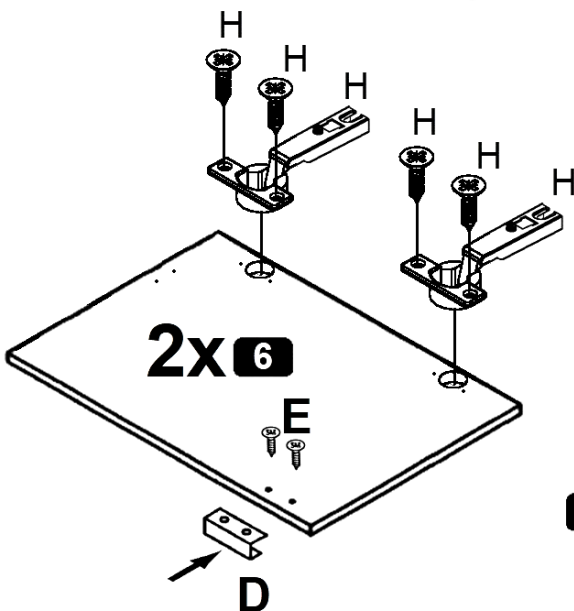
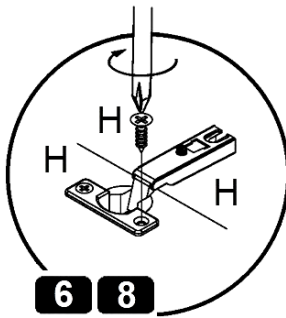
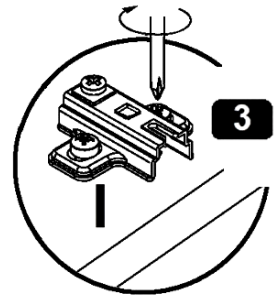
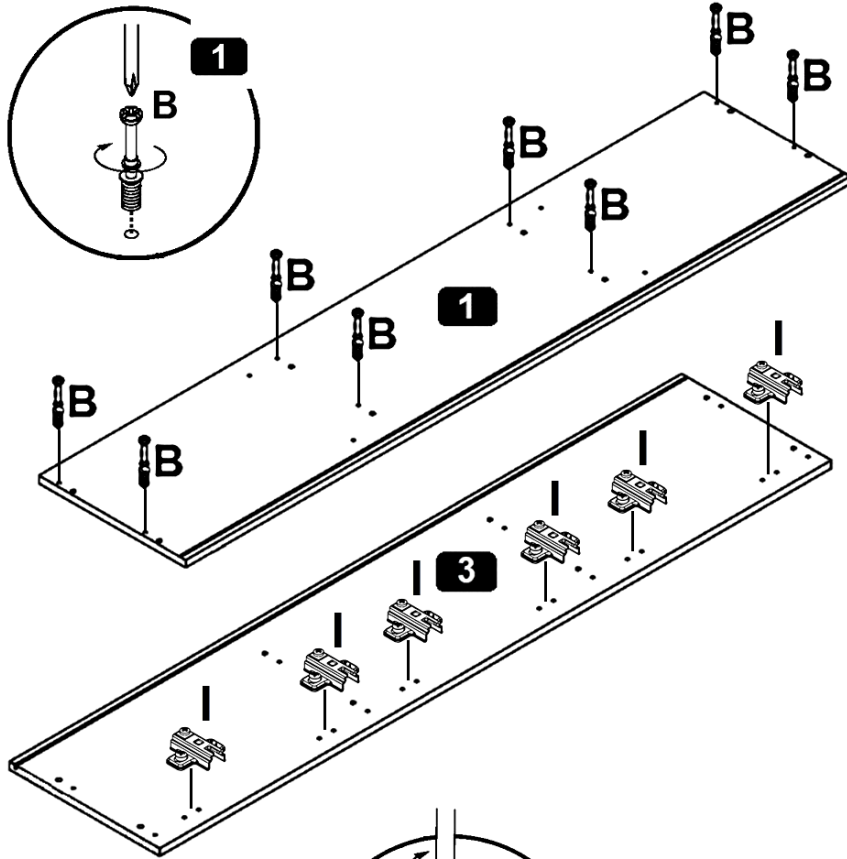
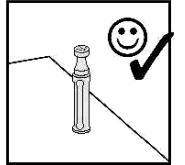
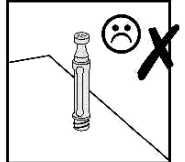
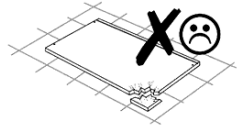
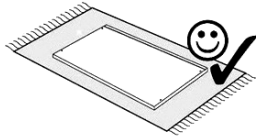

# 1

<b>B</b>  8x	<b>I</b>  h=2 6x	<b>H</b>  Ø35 Kr.0 3,5x13 mm 6x
<b>D</b>  3x	<b>E</b> 4,0 x 13 mm  6x	

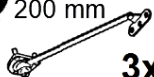

MA1

# 2

<b>A</b> 8,0 x 30 mm  16x	<b>C</b>  8x	<b>L</b> 200 mm  3x	<b>M</b> 3,5 x 13 mm  9x
---	--	---	--

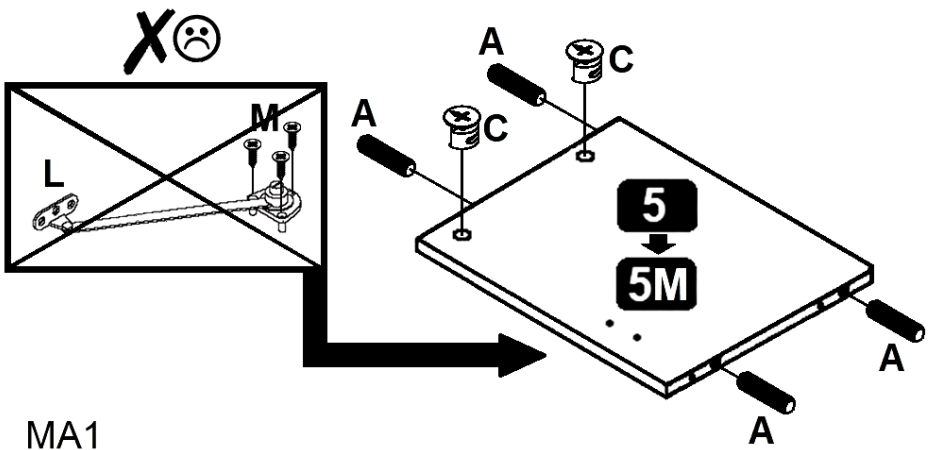
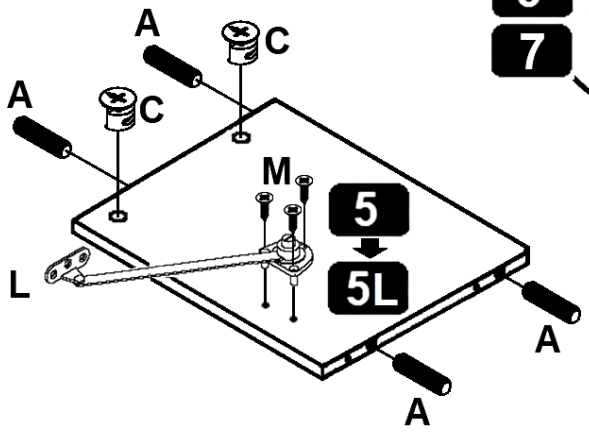
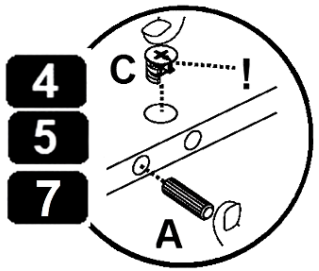
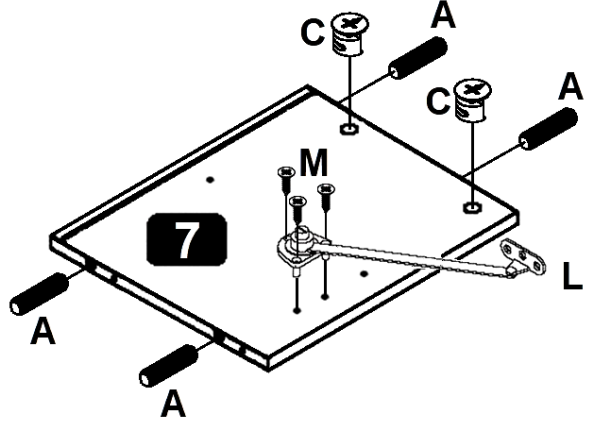
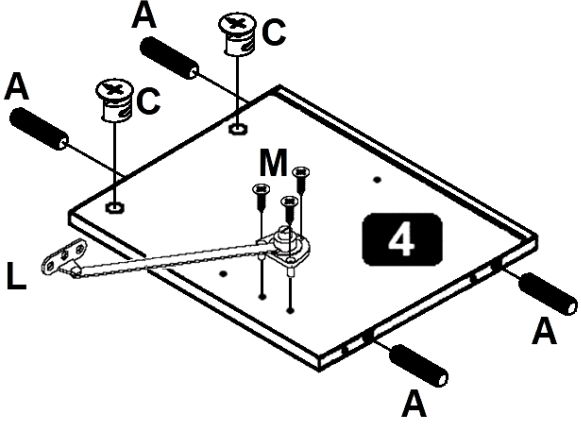
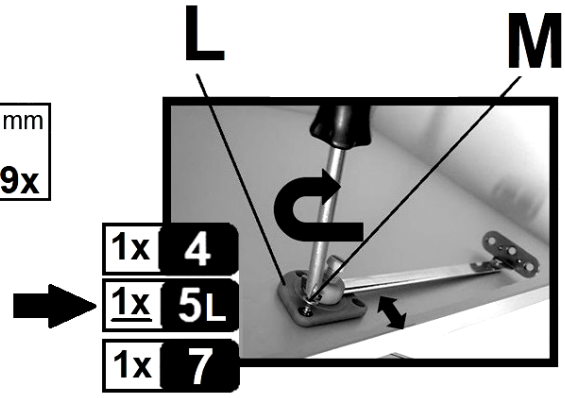
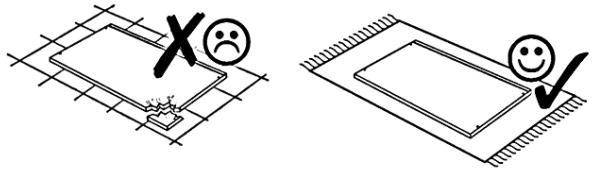

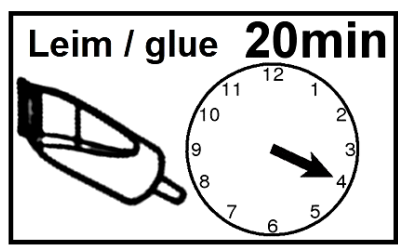
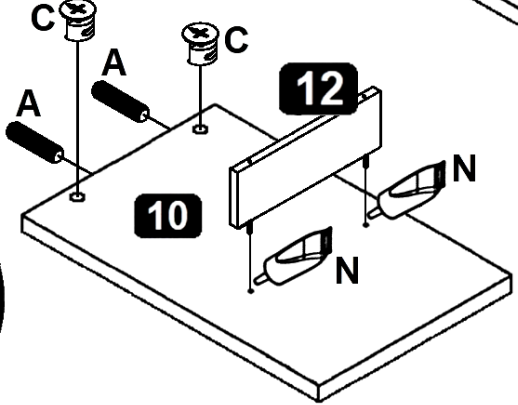
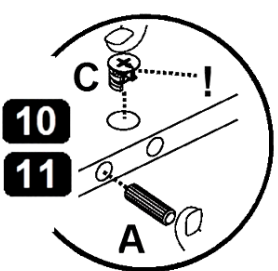
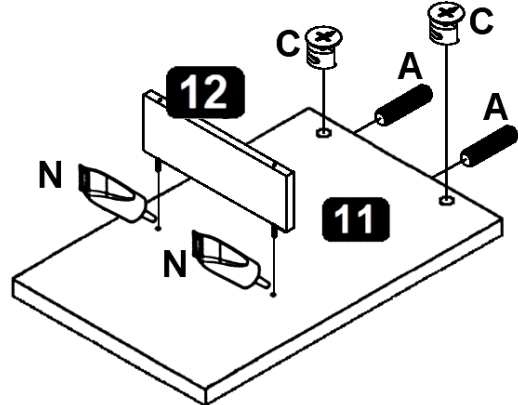
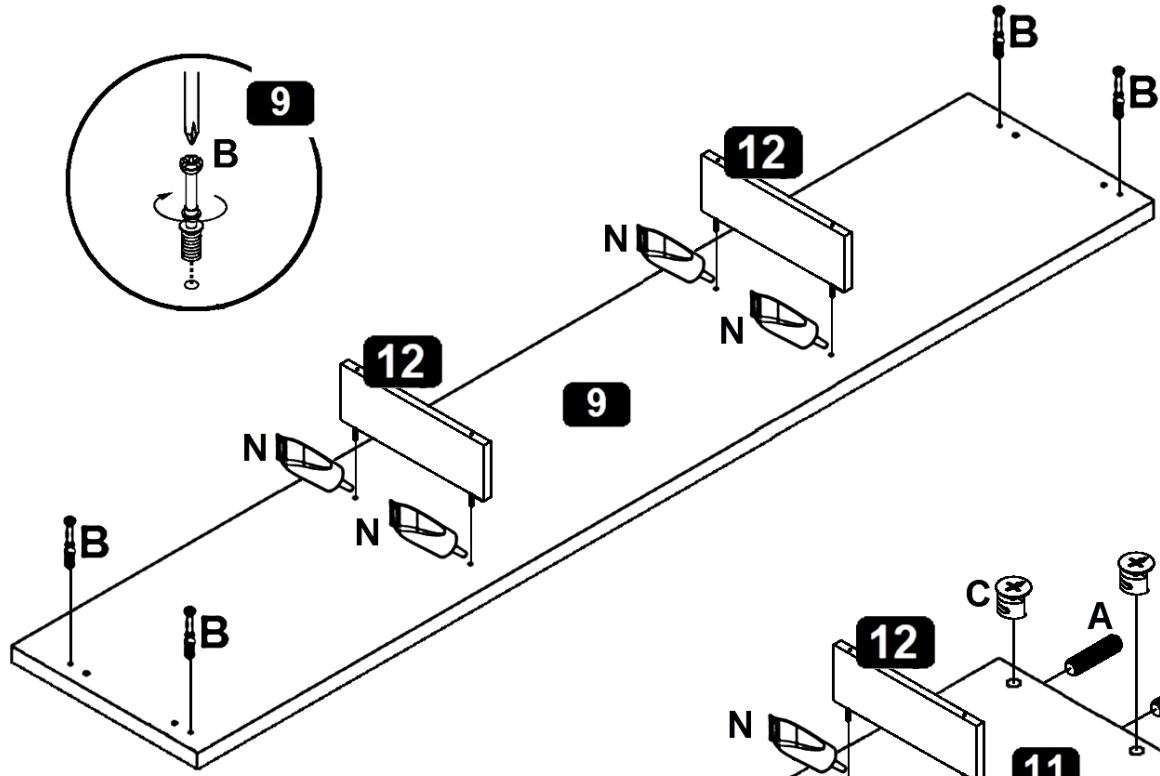
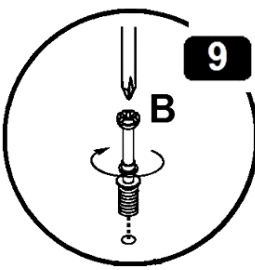
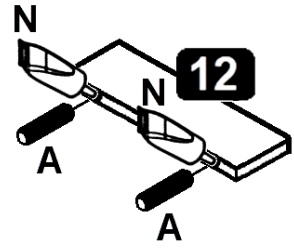
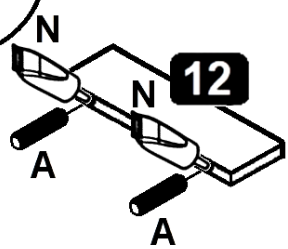
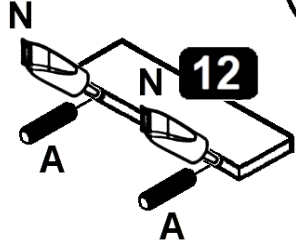
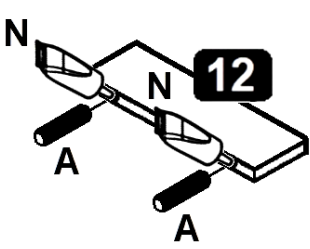
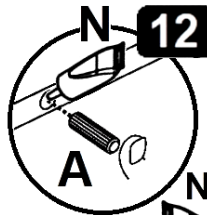
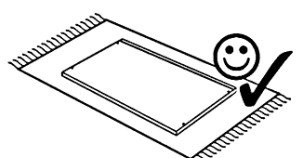
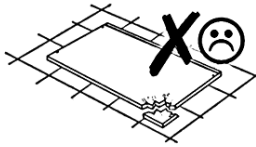
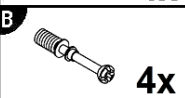
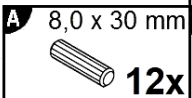

MA1

**3**



# 4

- F**  6x
- G**  4,0 x 20 mm 6x
- O**  5,0 x 50 mm 8x

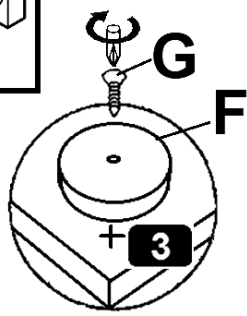
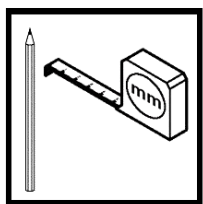
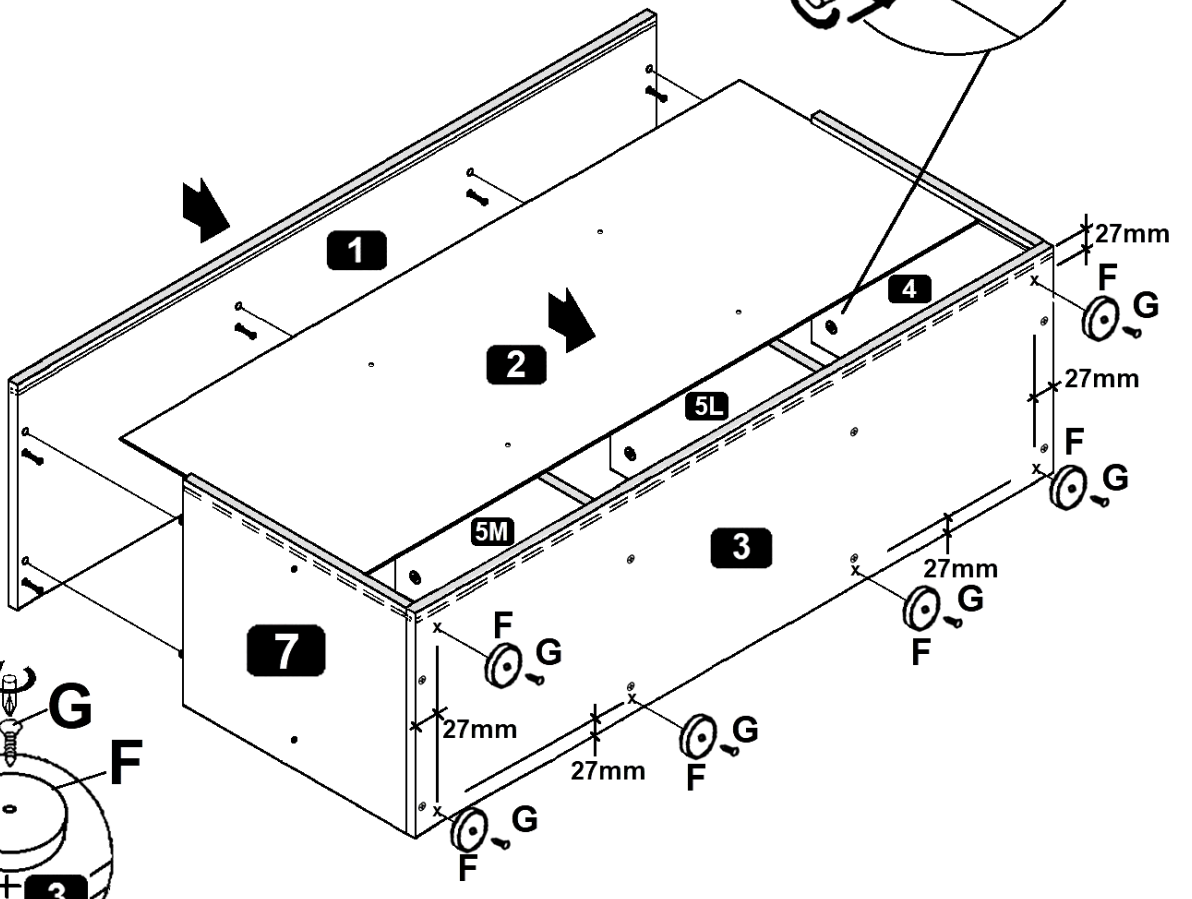
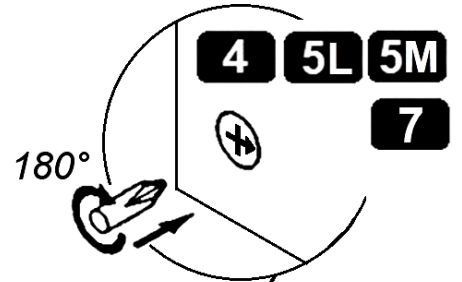
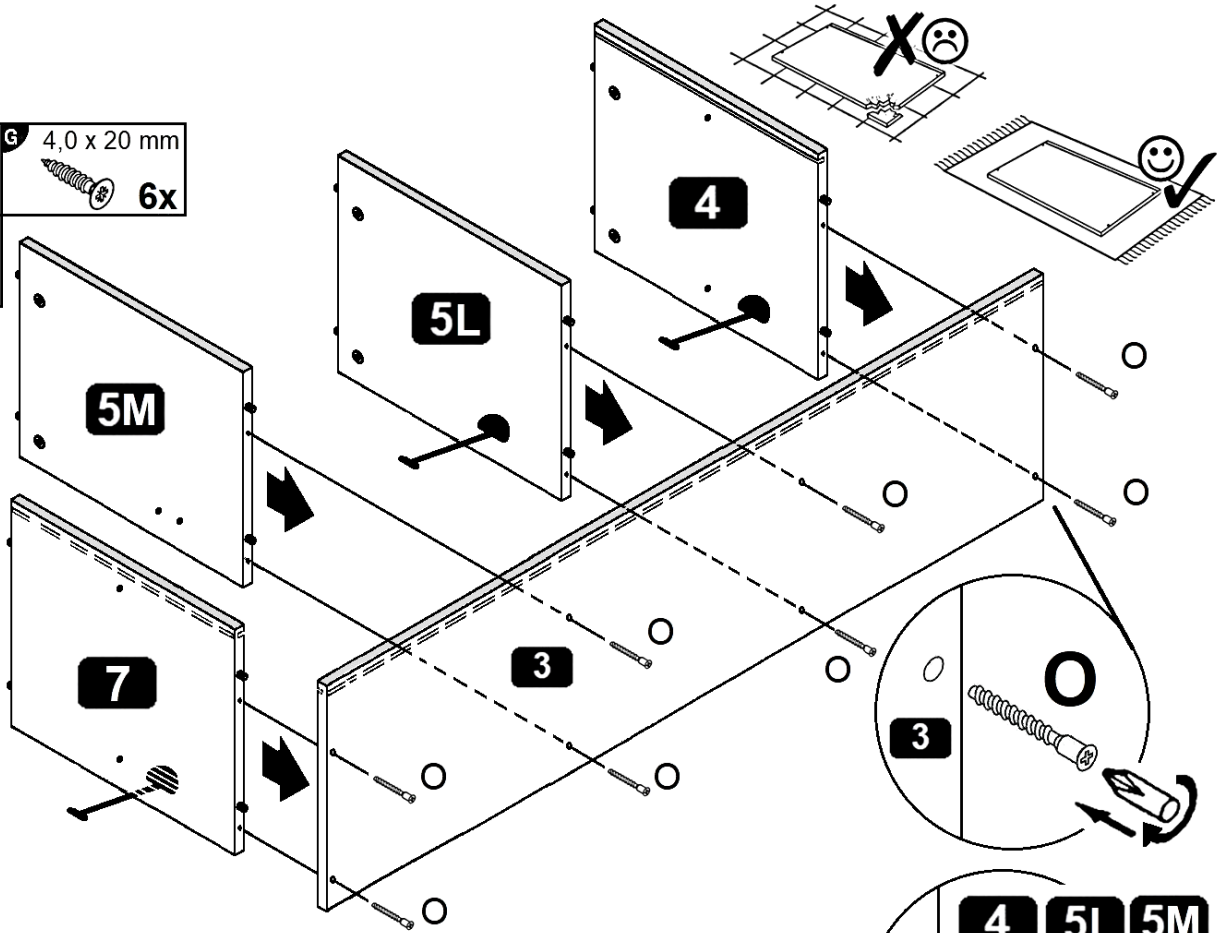

# 5

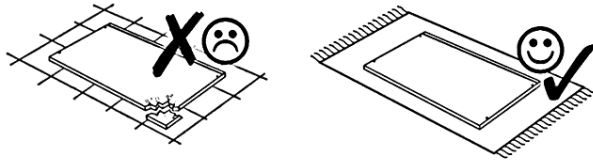

- J** 4x
- K** 2,7 x 20 mm
- 4x

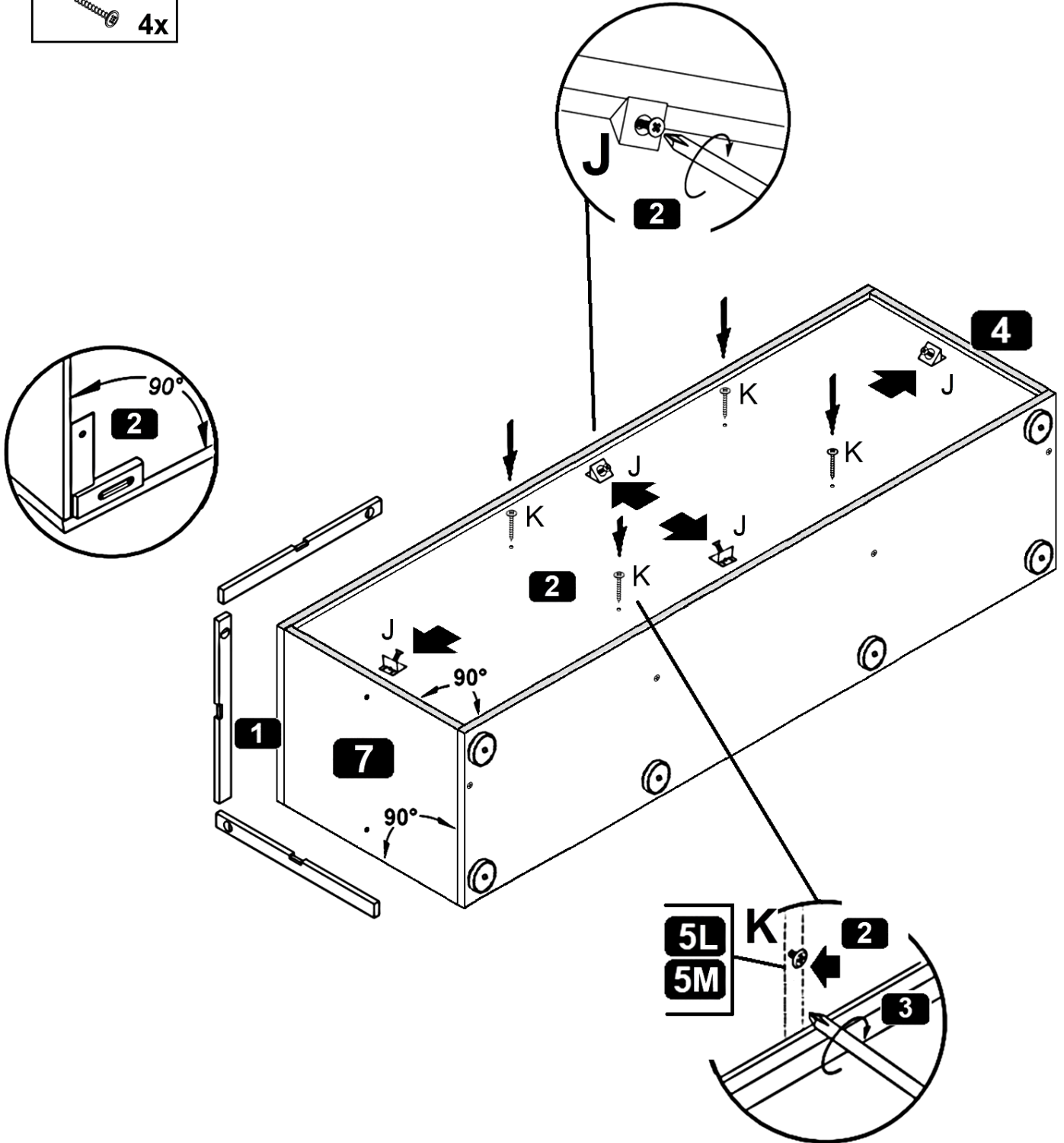

**6**

5,0 x 50 mm  
8x

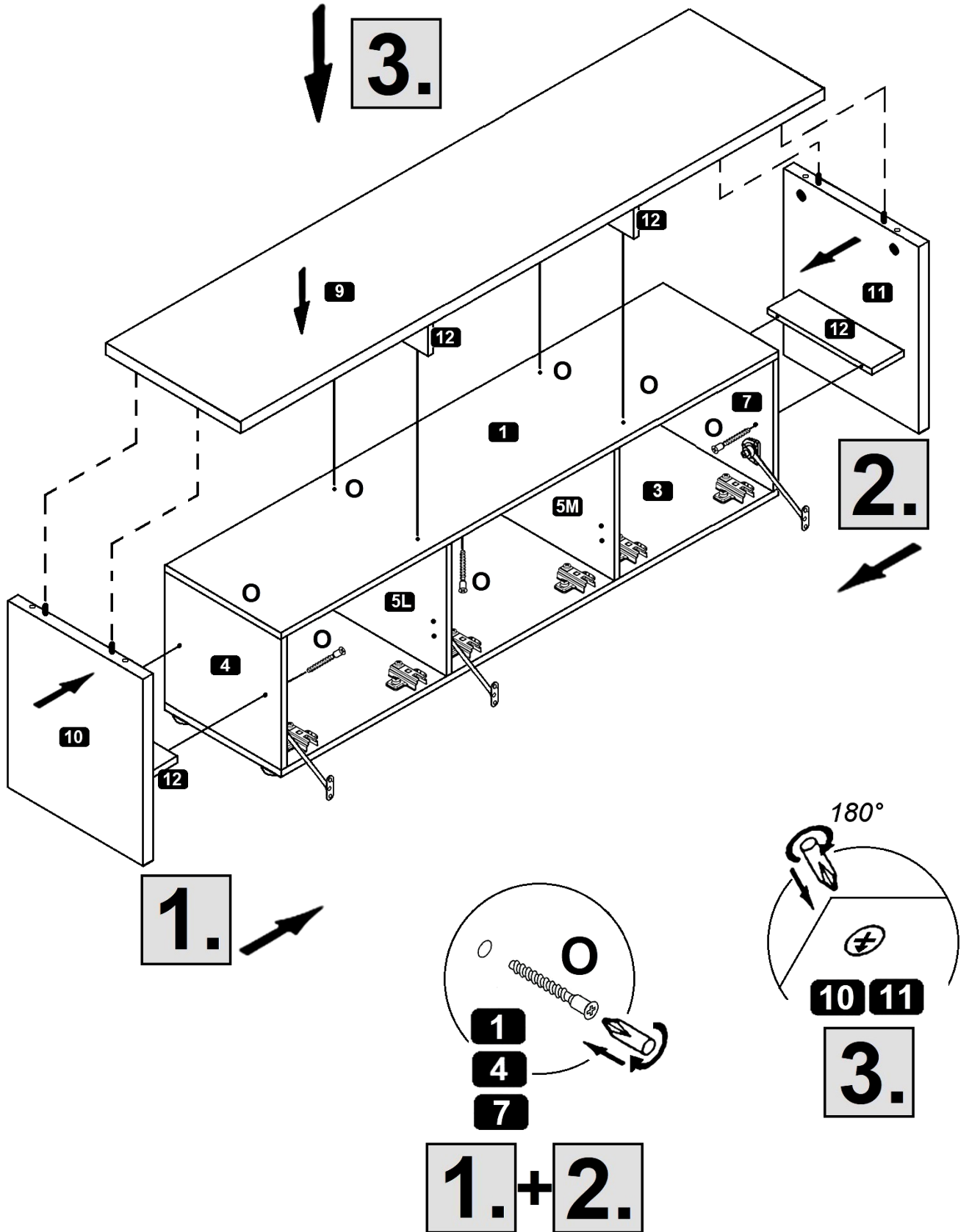
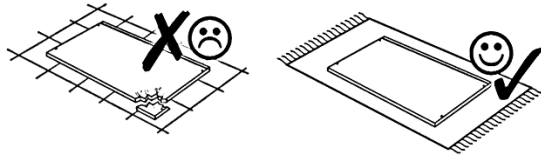



**7**

M 3,5 x 13 mm  
9x

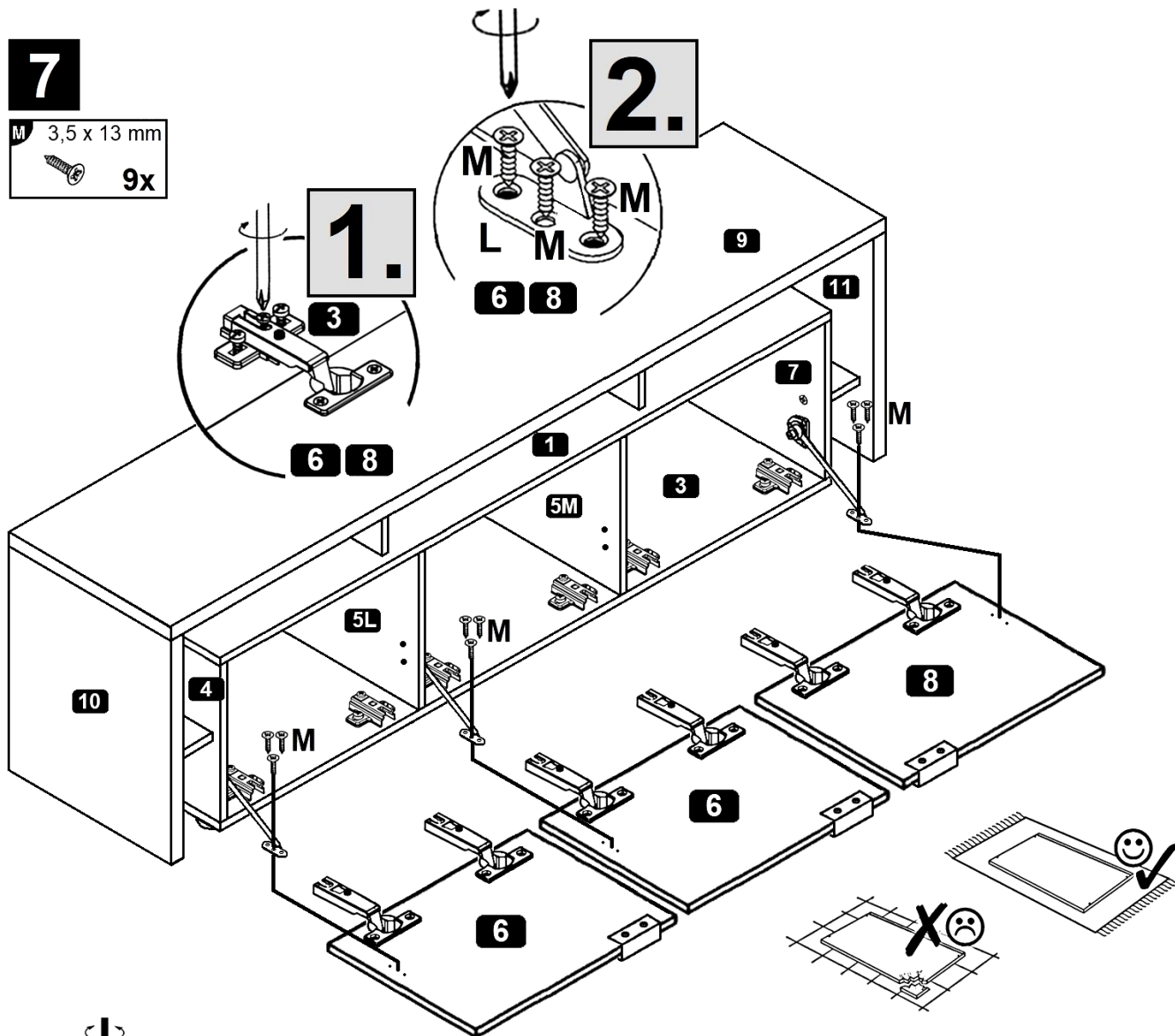

- (D) Bremskraft einstellen
- (GB) Adjust brake force
- (FR) Régler la force de freinage
- (IT) Regola la forza frenante
- (NL) Pas de remkracht aan
- (PL) Dostosuj siłę hamowania
- (CZ) Seřid'te brzdnu sílu
- (RO) Reglați forța de frână
- (HU) Állítsa be a fékerőt
- (SK) Nastavte brzdnu sílu
- (TR) Fren gücünü ayarlayın
- (RU) Отрегулируйте тормозное усилие

Ansicht von unten // bottom view

- (D) Bitte in Schraubenführung stecken. Eventuell Verstellerschraube leicht herausdrehen.
- (GB) Please put in screw guide. If necessary, unscrew the adjusting screw slightly.

**10/10**

- (D) Türen einstellen (Scharniere justieren)
- (GB) Adjusting the doors (adjusting the hinges)
- (FR) Régler les portes (ajuster les charnières)
- (IT) Sistemare le porte (regolare le cerniere)
- (NL) Deuren instellen (scharnieren afstellen)
- (PL) Nastawić drzwi (wyregulować zawiasy)
- (CZ) Vyrovnajte dvířka (seřid'te závěsy)
- (RO) Nastavenie dveri (nastavenie závesov)
- (HU) Állítsa be az ajtókat (állítsa be a zsanérokot)
- (SK) Reglare uši (ajustare balamale)
- (TR) Kapıların ayarlanması (menteselerin seviye ayarı)
- (RU) Регулировка дверей (регулировка шарнира)

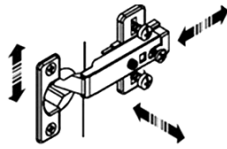

(D) Türen einstellen  
(Scharniere justieren)

(GB) Adjusting the doors  
(adjusting the hinges)

(FR) Régler les portes  
(ajuster les charnières)

(IT) Sistemare le porte  
(regolare le cerniere)

(NL) Deuren instellen  
(scharnieren afstellen)

(PL) Nastawić drzwi  
(wyregulować zawiasy)

(CZ) Vyrovnajte dvířka  
(seřid'te závěsy)

(RO) Nastavenie dverí  
(nastavenie závesov)

(HU) Állítsa be az ajtókat  
(állítsa be a zsanérokat)

(SK) Reglare uši  
(ajustare balamale)

(TR) Kapıların ayarlanması  
(menteşelerin seviye ayarı)

(RU) Регулировка дверей  
(регулировка шарнира)

