

Kate

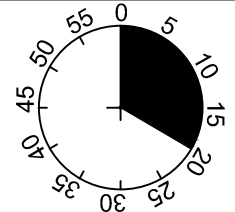
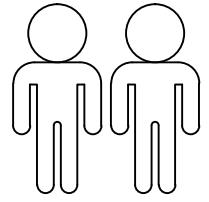
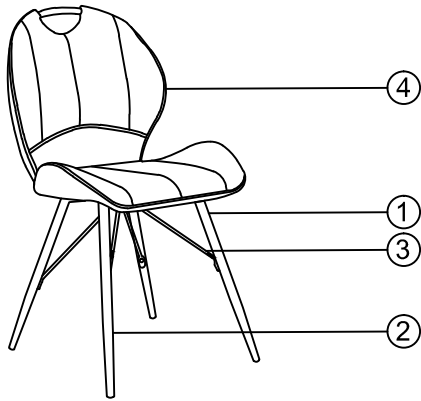

1

2

3

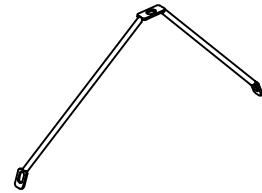
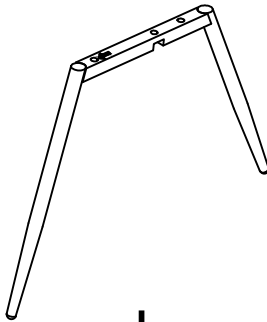
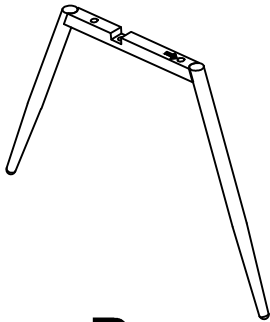



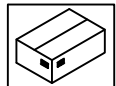
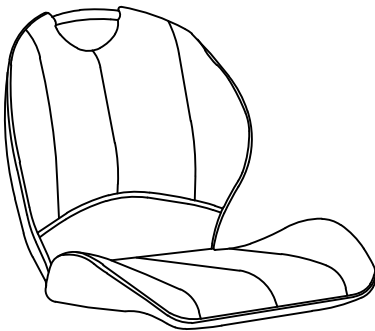

R

L

4

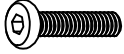
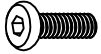

1	1x	2/2
2	1x	2/2
3	2x	2/2
4	1x	1/2

A	M6x45	B	M6x35	C	M6x13	D	Ø18xØ6x1.5	E	4MM
									
	4x		1x		4x		5x		1x

I.

1

L ← 2

E

A

D

4

A	M6x45
	2x
D	Ø18xØ6x1.5
	2x
E	4MM
	1x
75%	

2

R ← 1

E

A

D

A	M6x45
	2x
D	Ø18xØ6x1.5
	2x
E	4MM
	1x
75%	

3

C

E





3

C	M6x13
	4x
E	4MM
	1x
75%	

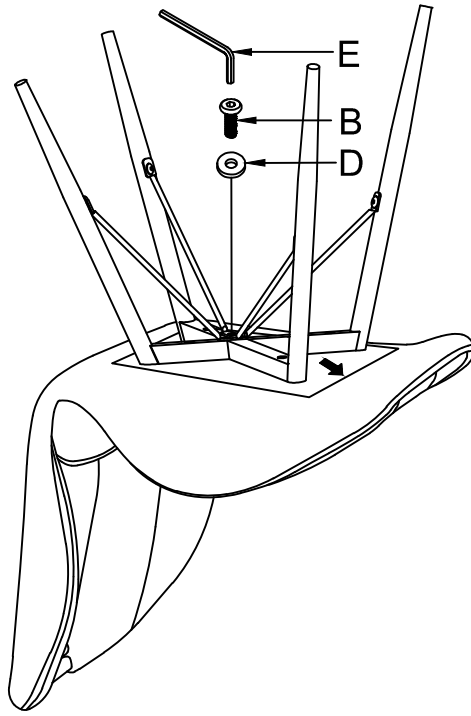
II.

4



B	M6X35		1x
D	Ø18xØ6x1.5		1x
E	4MM		1x
			

5



E	4MM		1x
