

"LINE" Glasbodenpaneel 120

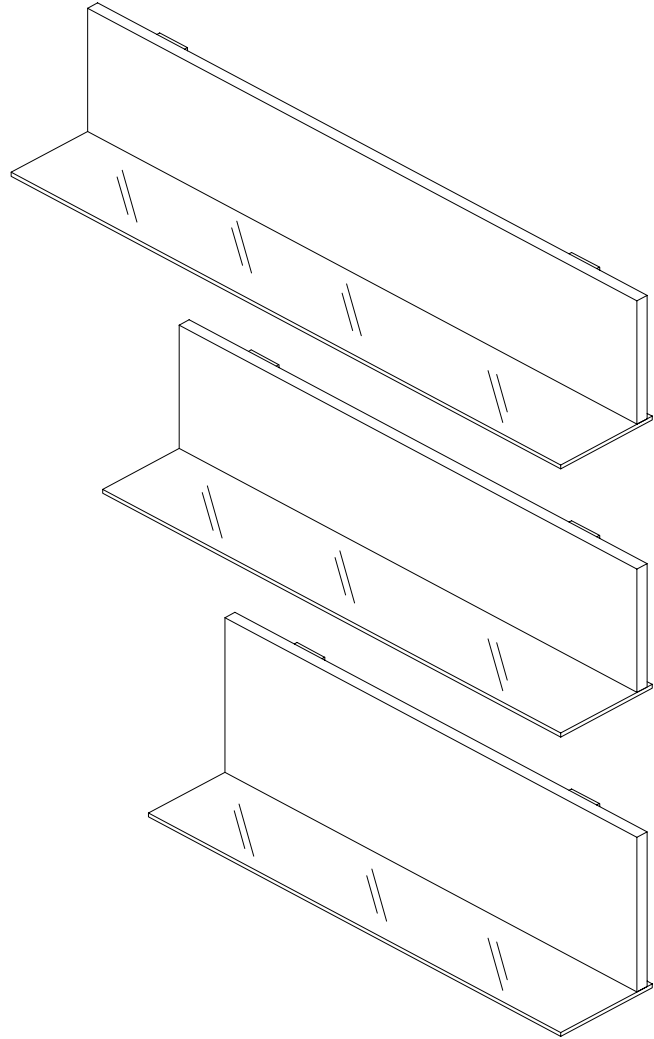

- D **Montageanleitung**
- NL **Handleiding voor de montage**
- TR **Montaj talimatı**
- GB **Assembly instructions**
- PL **Instrukcja montażu**
- RU **Инструкция по сборке**

D/A: Achtung: Die Befestigung des Möbelstückes an der Wand muss von einer fachkundigen Person vorgenommen werden, da für die Montage an die Wand angepasste Dübel erforderlich sind.

NL: Opgelet: Een vakkundige persoon dient het meubelstuk aan de muur te bevestigen; voor de montage aan de muur zijn immers aangepaste pluggen vereist.

TR: Dikkat: Mobilya parçasının duvara sabitlenmesi, duvar montajı için özel uyarlanmış dübeller gerektirdiğinden bu iş sadece bu konuda uzman bir kişi tarafından gerçekleştirilmelidir.

GB: Attention: A qualified professional is required when mounting furniture to the wall since dowels corresponding to the wall are required for this.

PL: Uwaga: Mocowanie mebla do ściany może przeprowadzić wyłącznie odpowiedni do tego personel, ponieważ w czasie montażu w ścianie konieczne jest zastosowanie dopasowanych kołków.

RUS: Внимание: Поскольку для монтажа на стене необходимо использовать специальные дюбели, мебель должна быть закреплена на стене квалифицированным персоналом.

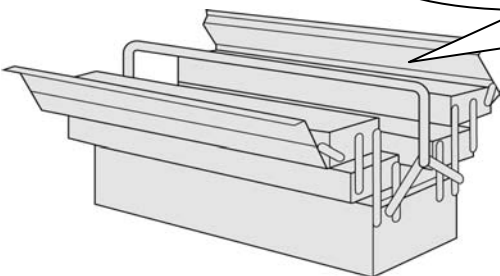
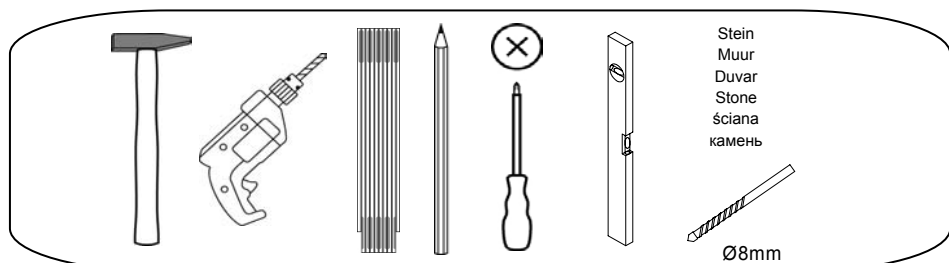
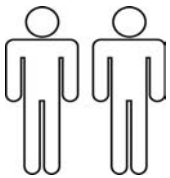

Service • Dienstverlening • Serwis • Servis • Сервисная служба

Name • Naam • Nazwa • Isim • Название

LINE

Typ • Type • Тип • Тип





Glasbodenpaneel 120

Nr. • No. • Номер

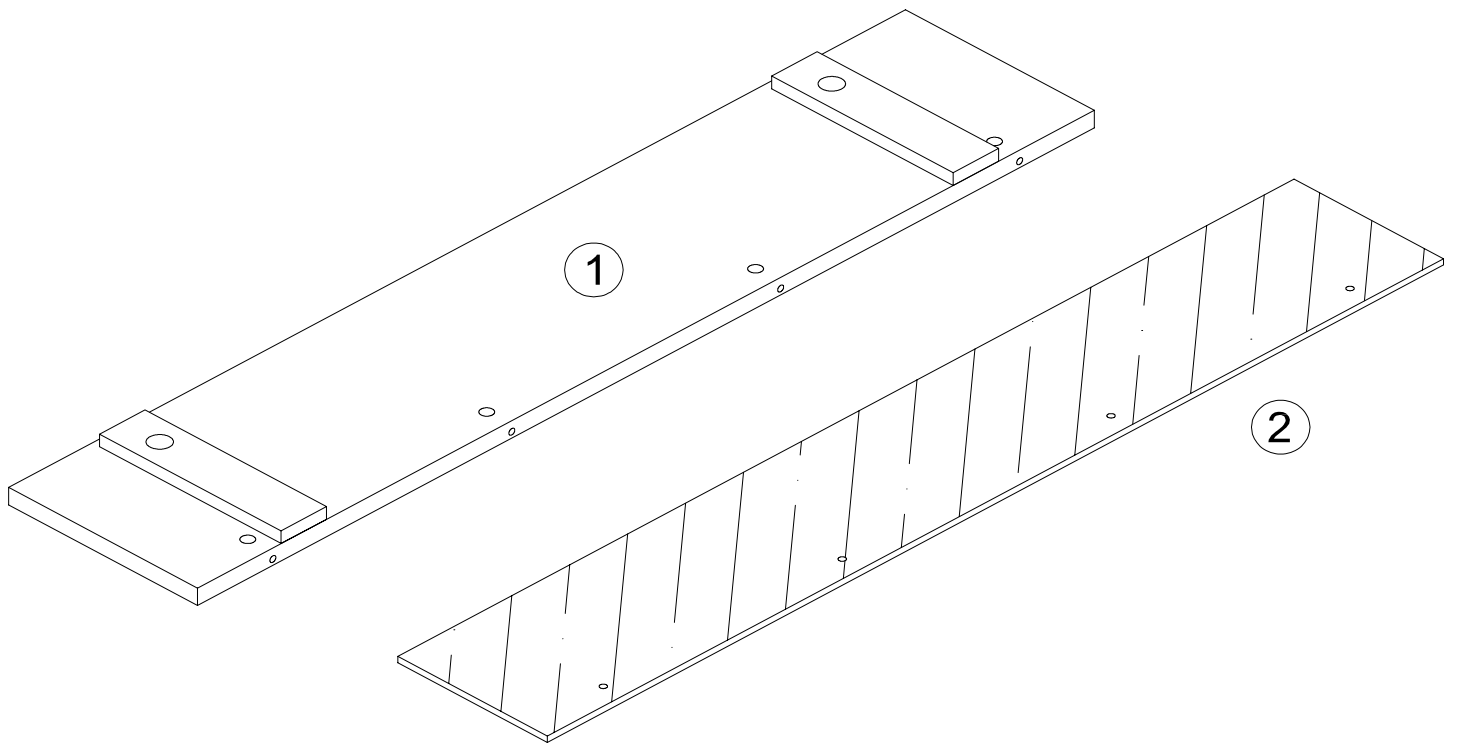
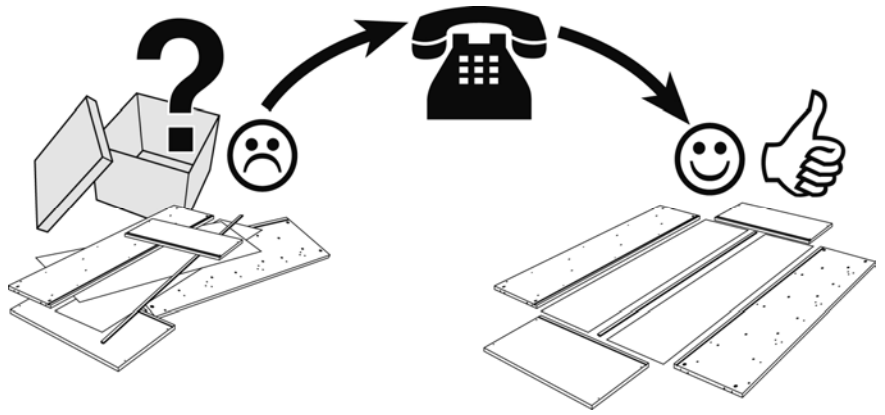
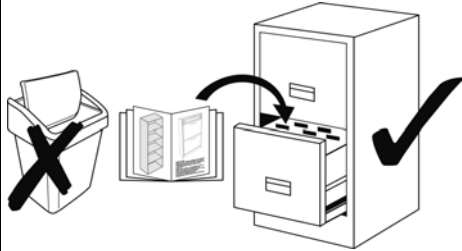
248 847 // 298 772 // 324 507

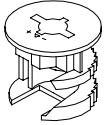
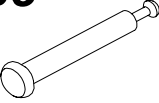
 **Schwarz // Weiß // Grau**

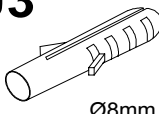
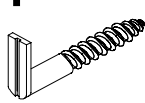

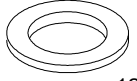
A1 	B9 	P10  3,5 x 13 kl. Kopf	U3  Ø8mm	U4 	U6 	X20  12 mm
4	4	4	2	2	2	4

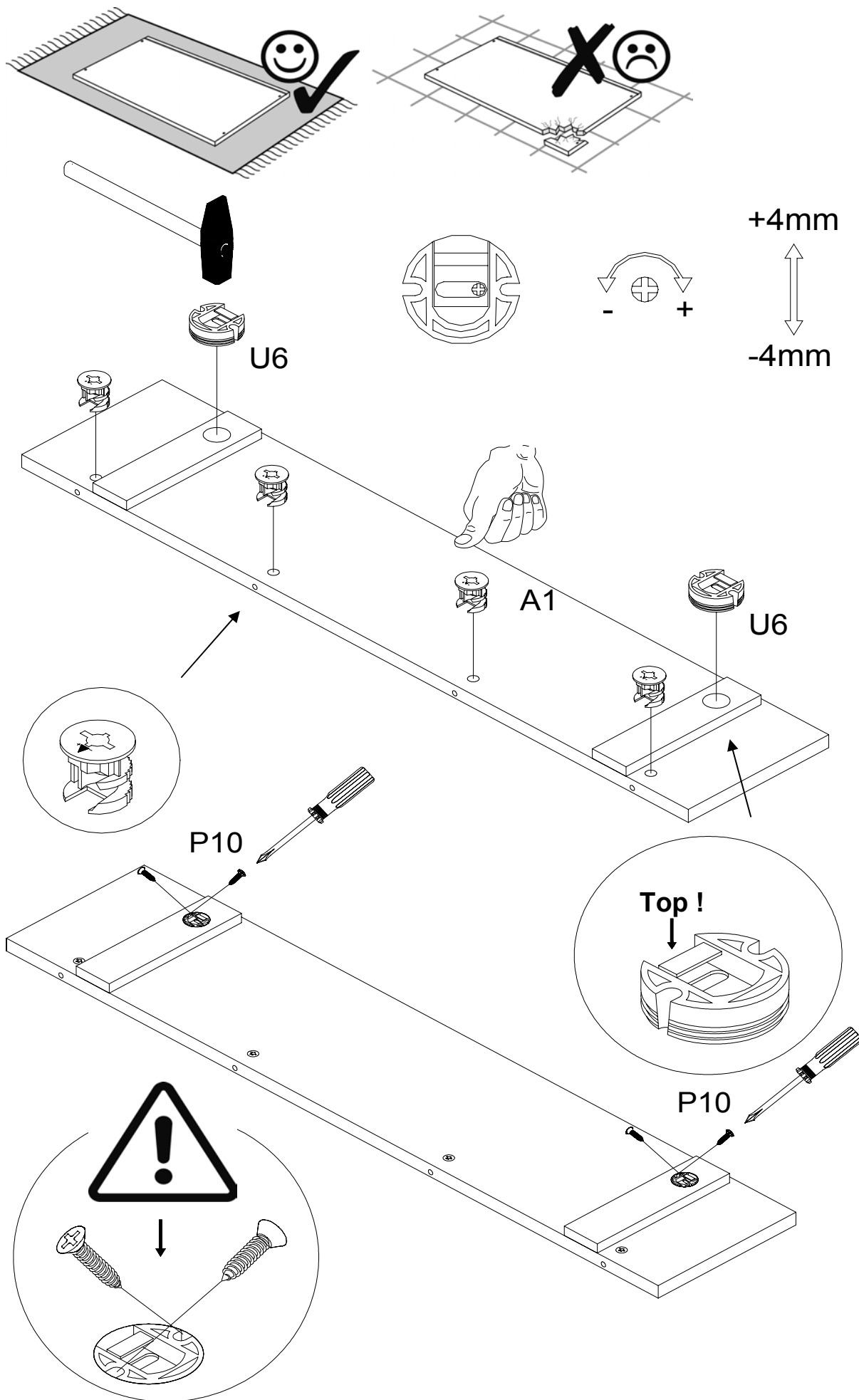

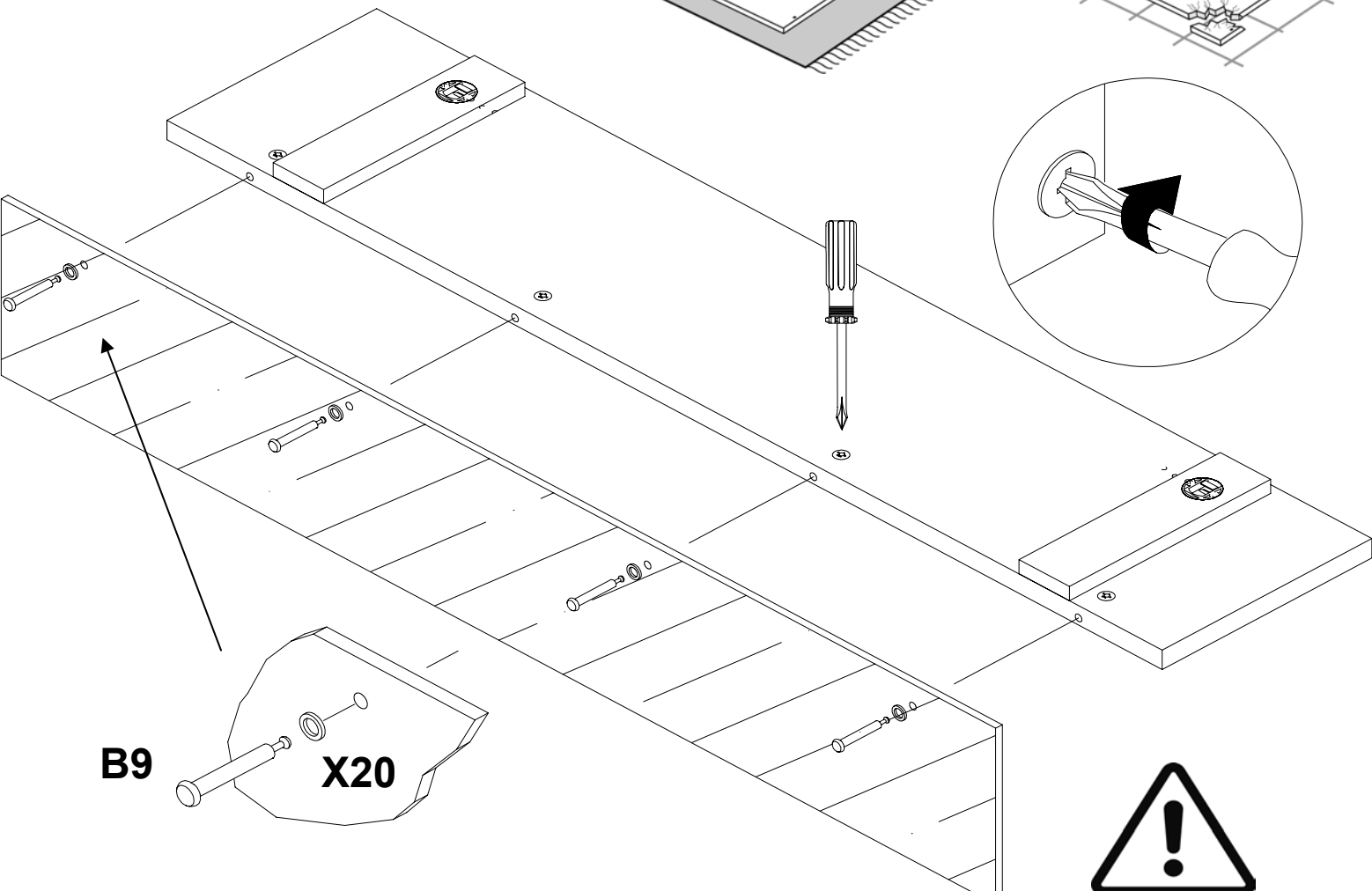
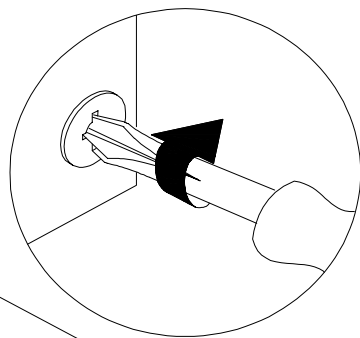
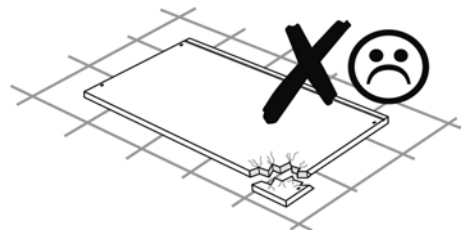
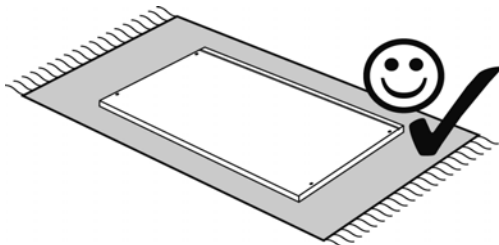

B9

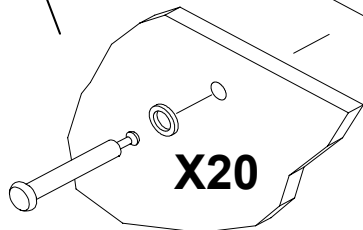

X20



Optional !

BNR: 299 083

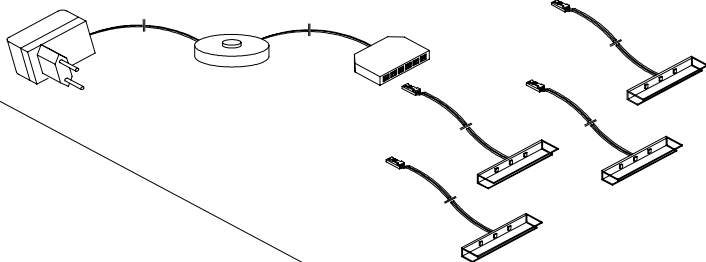
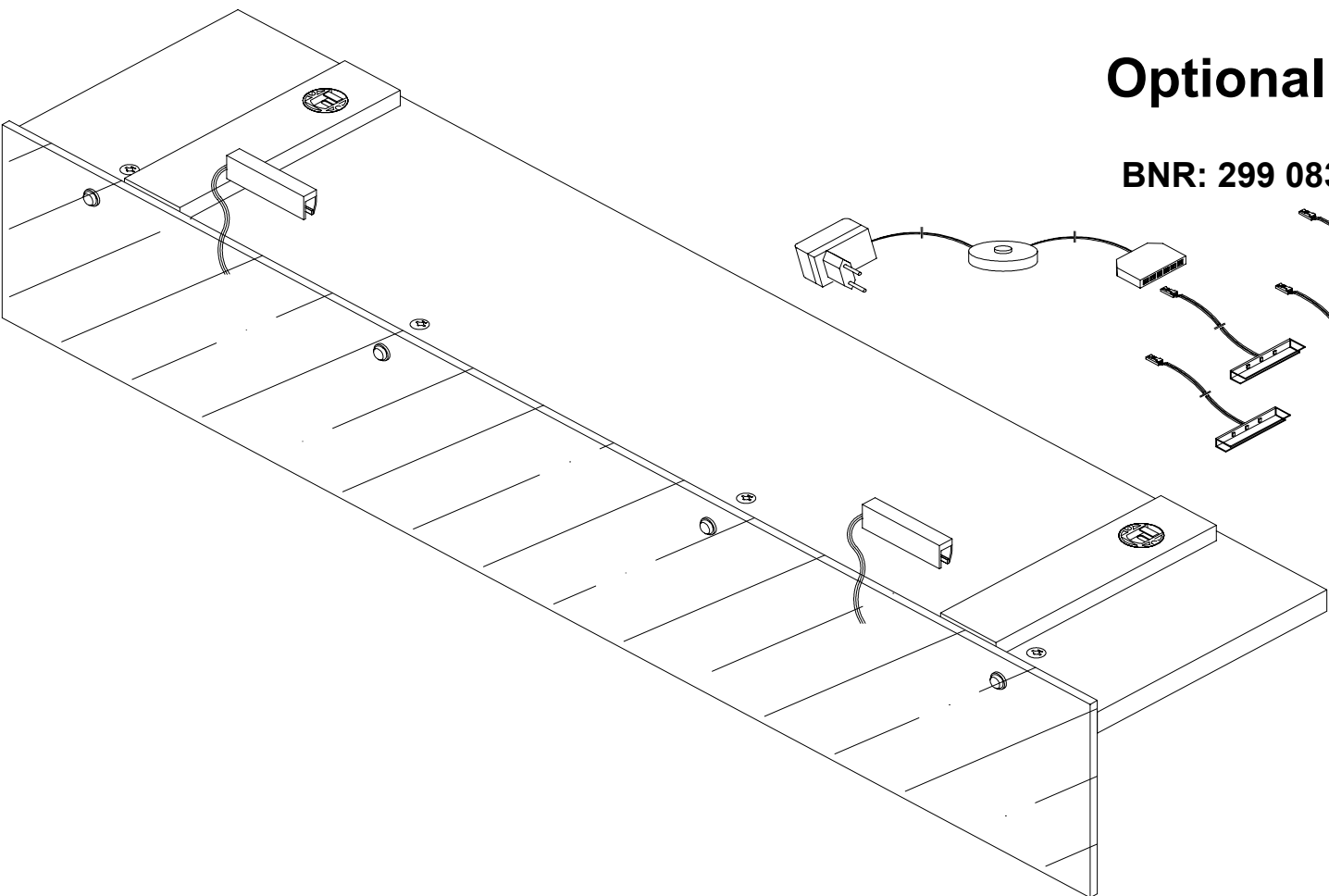

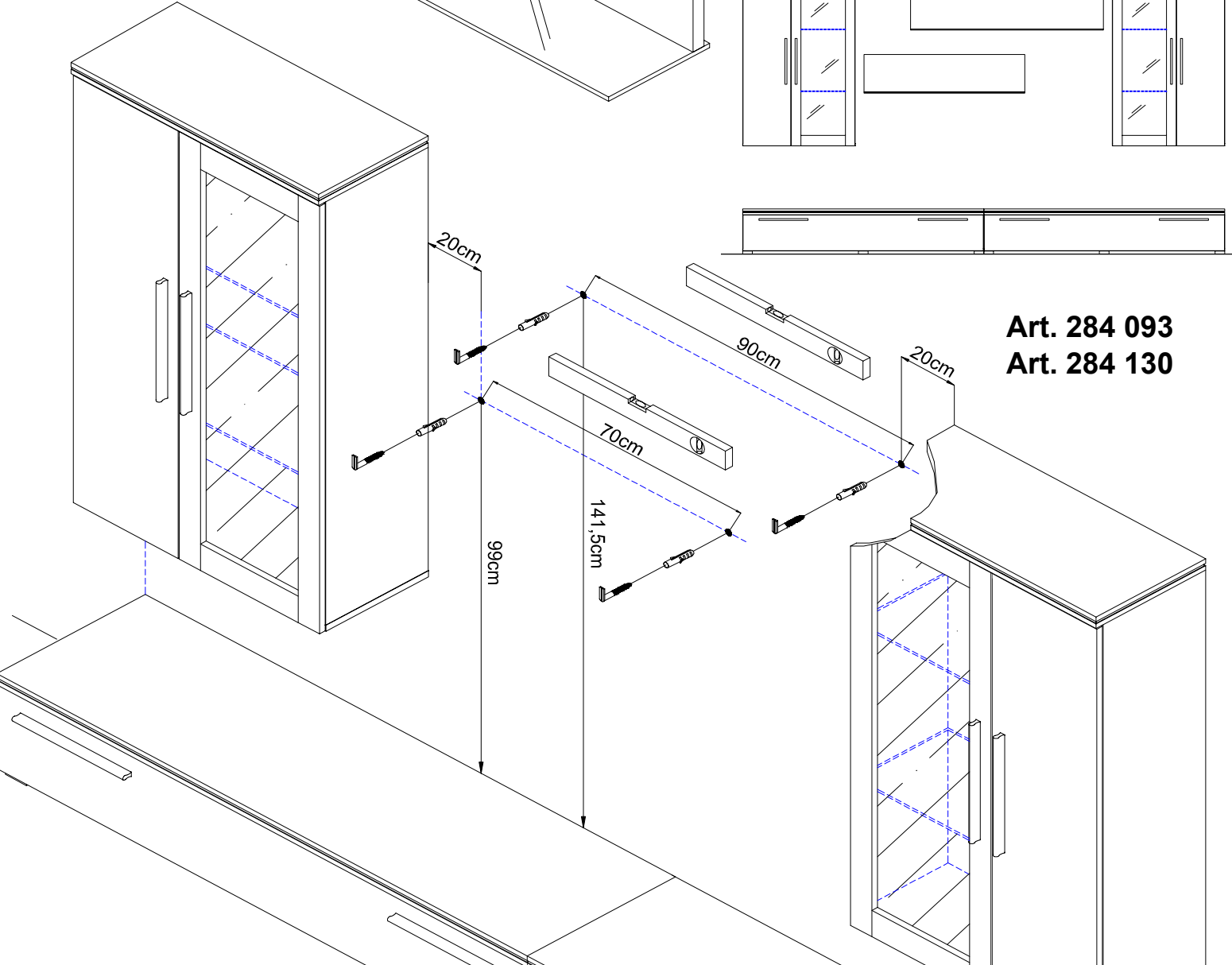
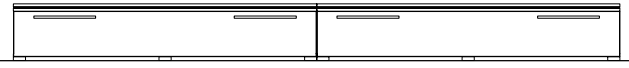
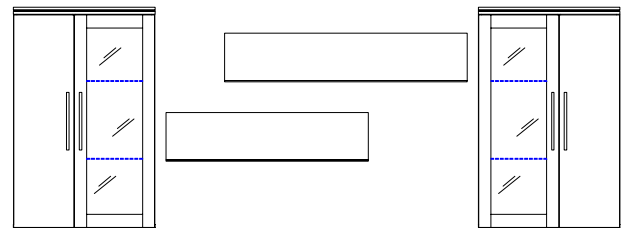
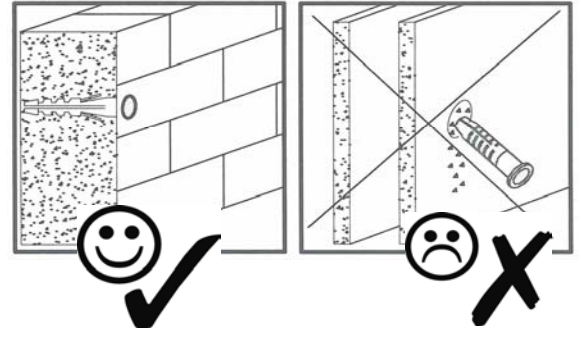
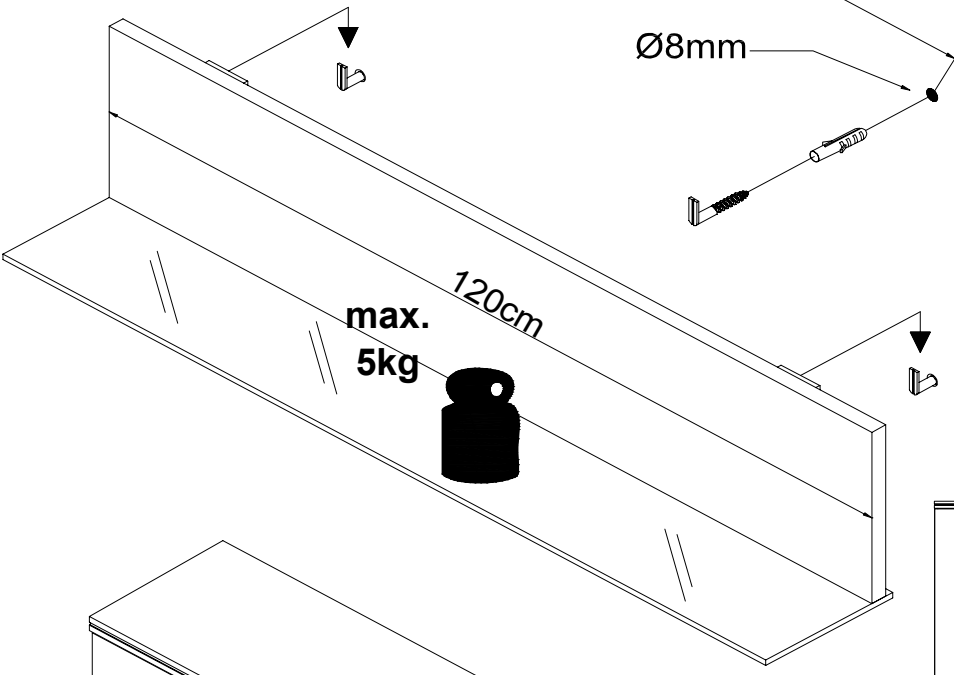
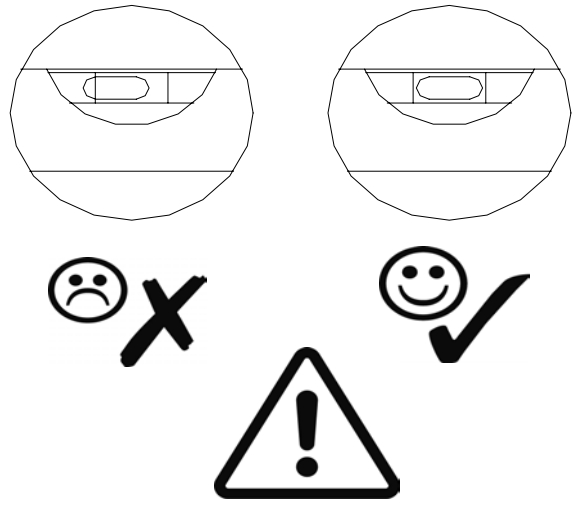
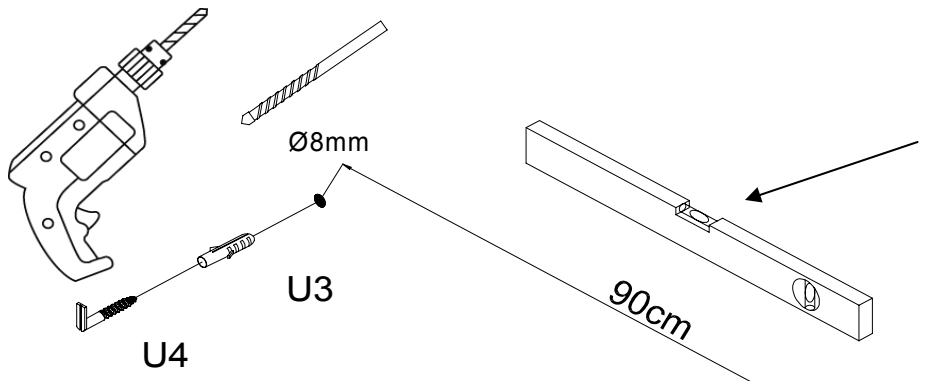

Art. 284 093
Art. 284 130