



(D) Montageanleitung

(GB) Assembly instructions

(FR) Notice de montage

(TR) Montaj talimatı

(IT) Istruzioni di montaggio

(NL) Handleiding voor de montage

(RU) Инструкция по монтажу

(CZ) Montážní návod

(HU) Szerelési útmutató

(RO) Instrucțiuni de montaj

(PL) Instrukcja montażu

(SK) Návod na montáž

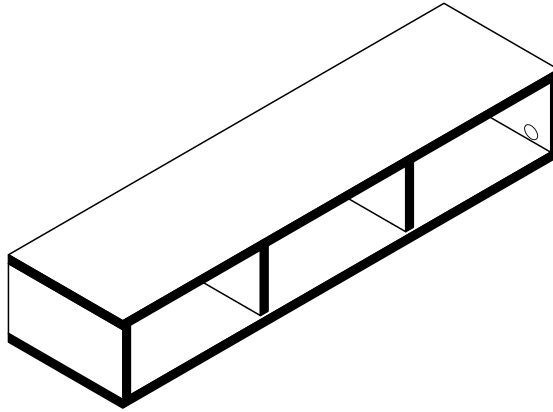
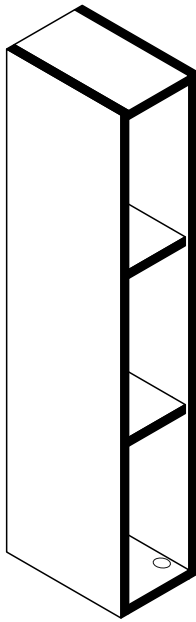









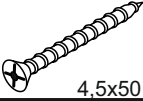

0771-HR_00-120 Hängeregale

REPC-Nr.:

Service • Assistenza • Dienstverlening • Servis
Servis • Szerviz • Сервисная служба

			<p>Colli 1/1: (1) (2) (3) (4) (5) Beutel 1/1</p>

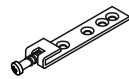
Beutel 1/1

1-80	 3,5x13	1-174	 4,5x50	2-10	 14x	2-20	 14x	2-103	 8x	5-20	 8x
6x		4x		14x		14x		8x		8x	
5-130		8-70	 Ø8	8-90	 2x	8-91	 2x				
2x		4x		2x		2x					

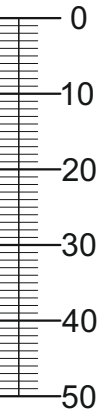

Colli 1/1

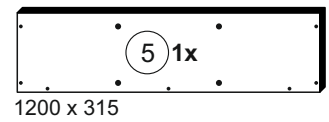
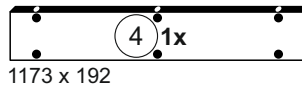
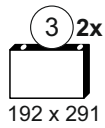
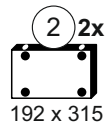
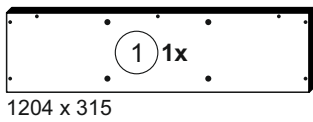

1

2-20	
7x	

①

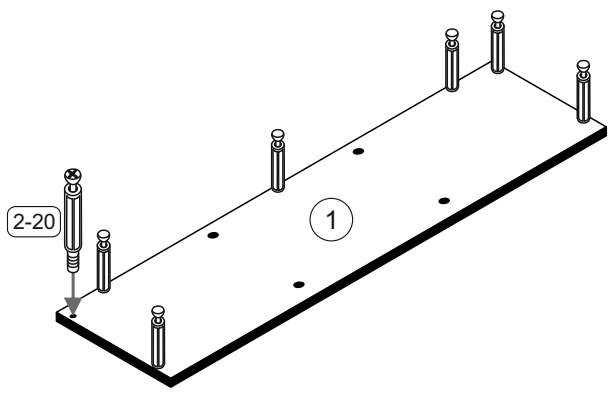

2

2-10	
8x	

②

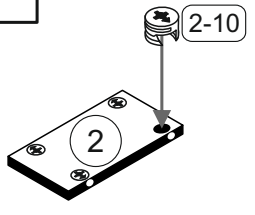
3

2-103	
8x	8x30
5-130	
1x	

③

4

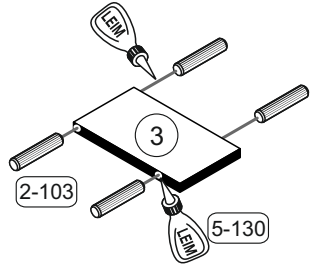
2-10	
6x	

④

5

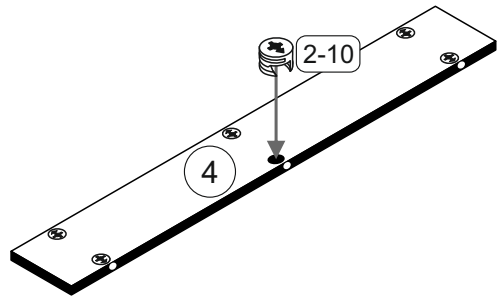
2-20	
7x	

⑤

6

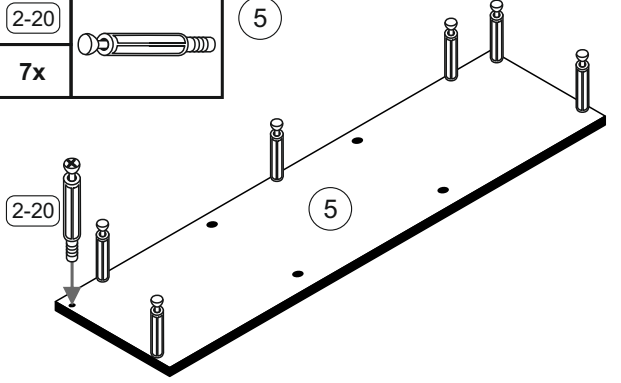
5-130	
1x	

⑥

7

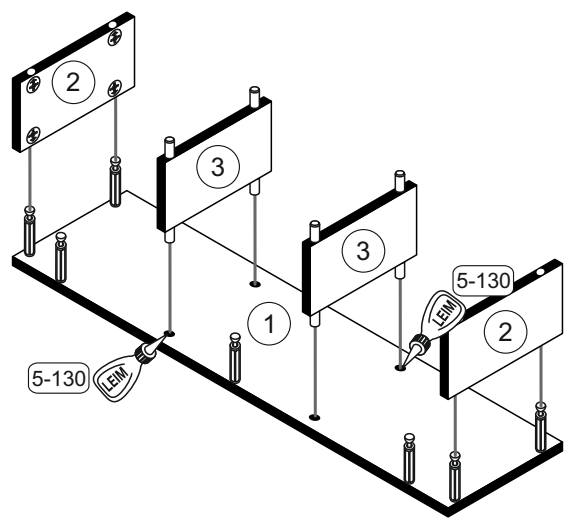
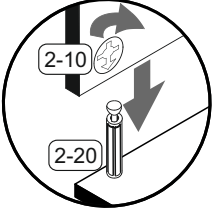

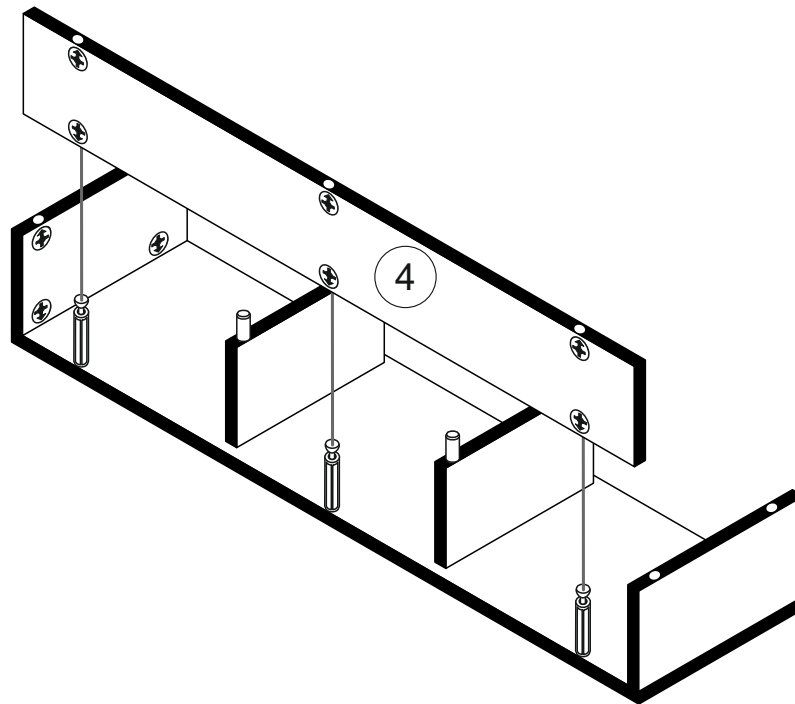
8



5-20		5-130	
8x		1x	

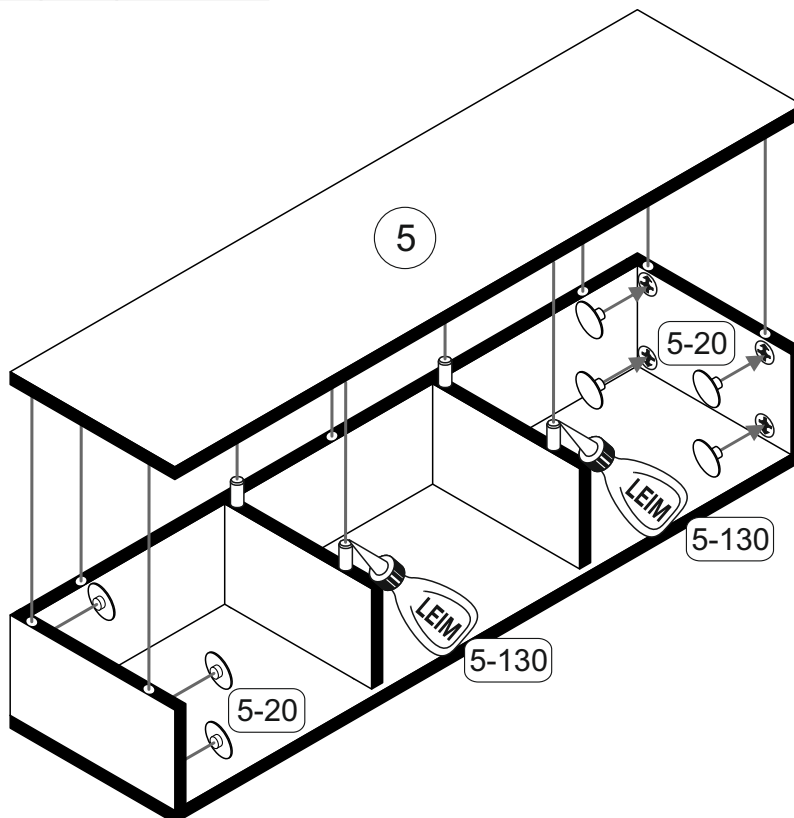



Schablone zum aufhängen

(hierzu die Ecken des Blattes in die Ecke zwischen Seite und Oberplatte anlegen und mit einem Dorn die Löcher vorstechen.)

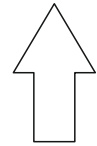

vertikale
Aufhängung

horizontale
Aufhängung

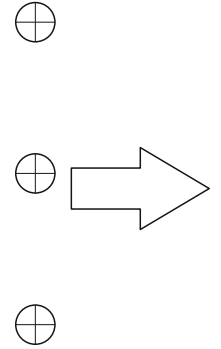
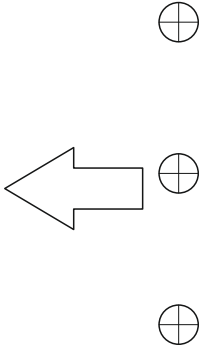
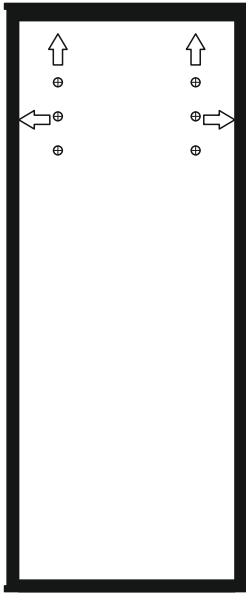

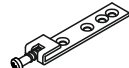
1-80		8-90	
6x	3,5x13	2x	

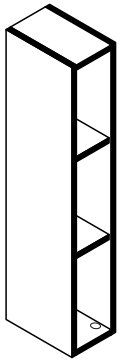

vertikale
Aufhängung

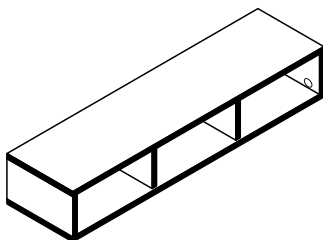
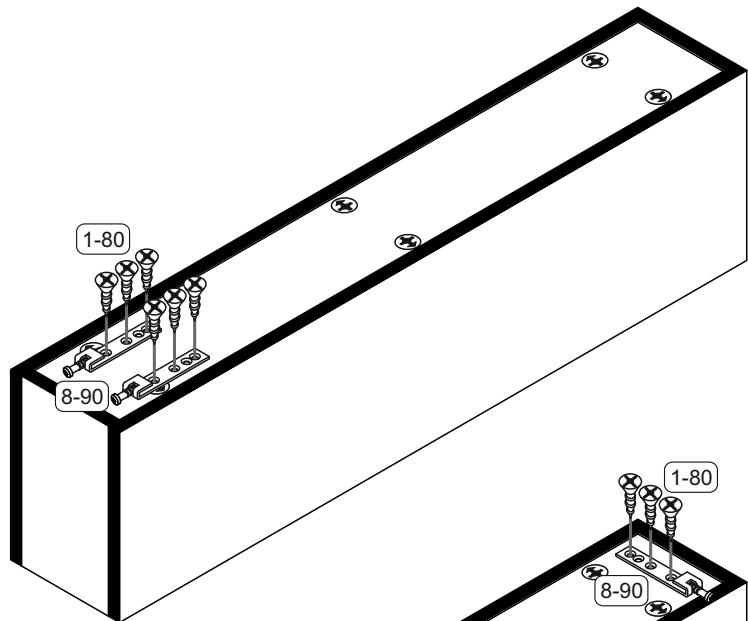

horizontale
Aufhängung

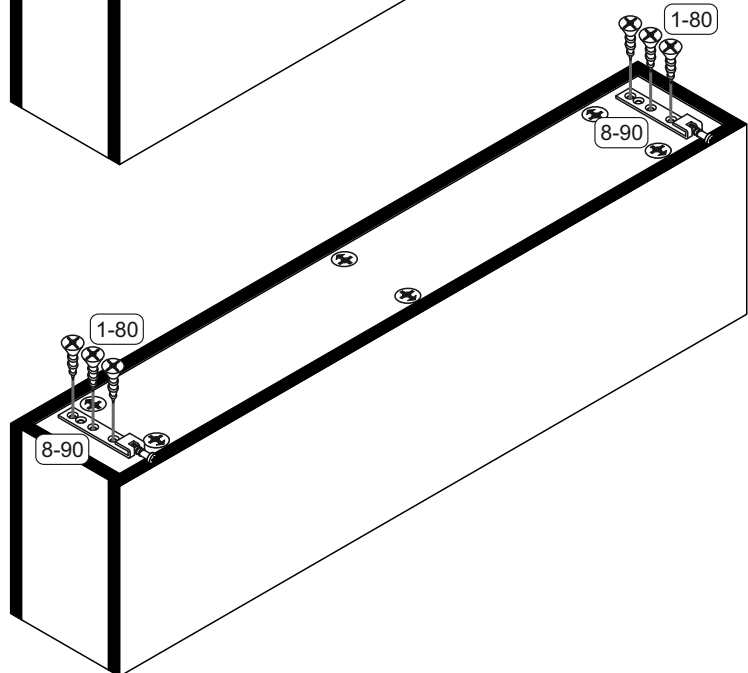

10



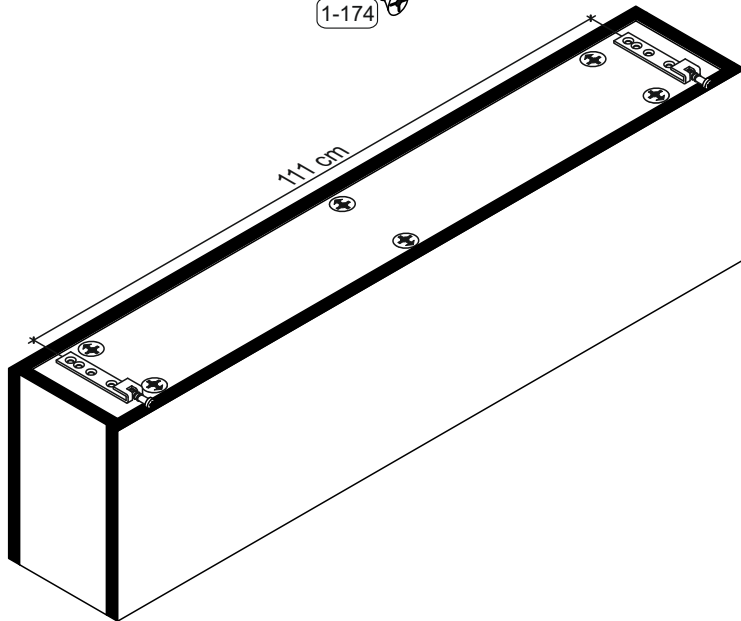
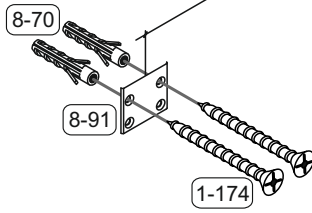
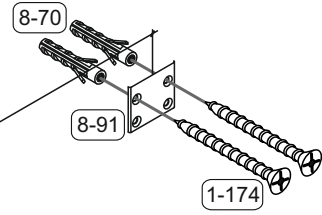
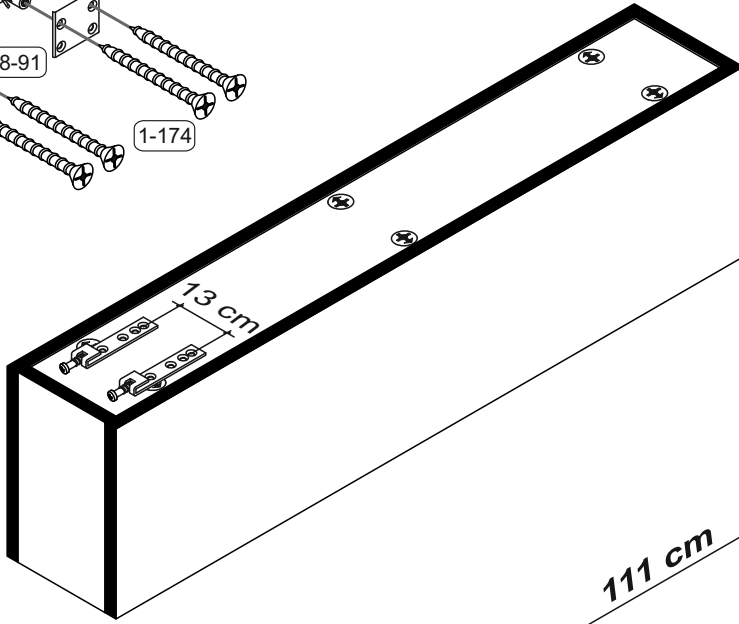
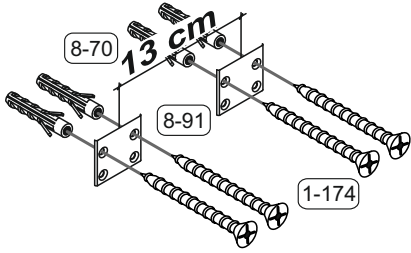
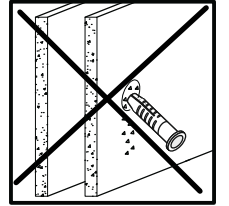
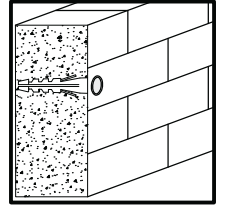
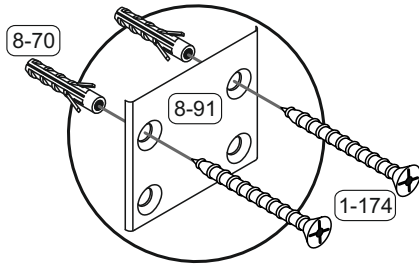

1-174		8-91		8-70	
4x	4,5x50	2x		4x	Ø8

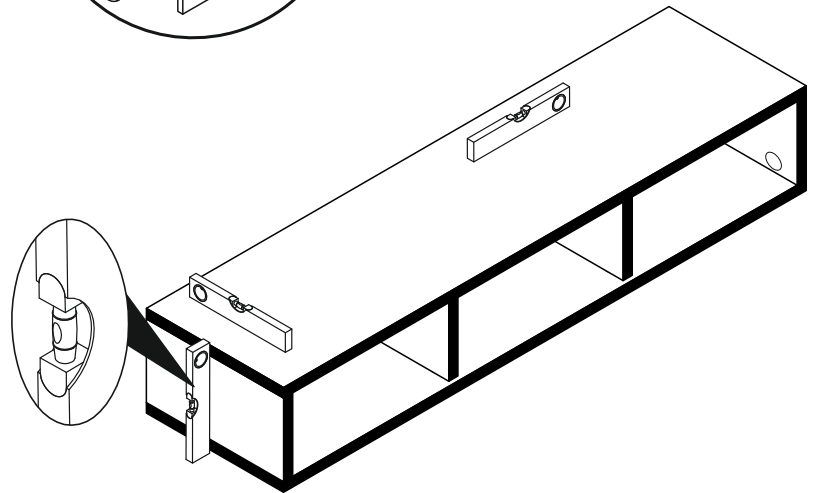
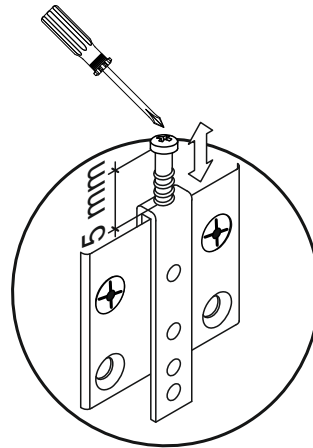
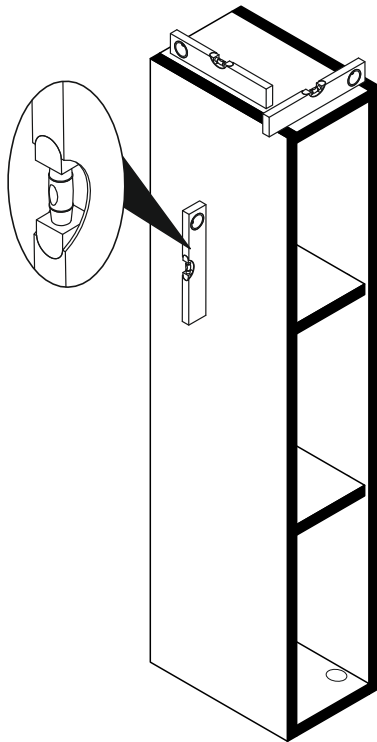

11



 Achtung • Attention • Attenzione • Opgelet • Uwaga • Pozor • Figyelem • Atenție • Dikkat • Внимание 	
(D)	Wandbefestigung dient als Kippschutz - unbedingt anbringen! Bei einigen Wandtypen kann ein Spezialdübel erforderlich sein!
(GB)	The wall fastening serves to prevent tipping - be absolutely sure to mount it! For certain wall types, a special wall plug may be necessary!
(FR)	La fixation murale sert de protection contre le basculement – à installer impérativement ! Pour certains types de murs il faut des chevilles spéciales !
(TR)	Duvardaki sabitleme, devrilmeye karşı bir emniyet tedbiridir ve mutlaka monte edilmelidir! Bazı duvar tiplerinde bunun için özel bir dübel gerekli olabilir!
(IT)	Il fissaggio alla parete serve da protezione anti-ribaltamento – attaccarla assolutamente! Per alcune strutture di parete può essere necessario un tassello speciale!
(NL)	Bevestiging aan de muur dient als kantelbescherming – zeker en vast bevestigen! Bij enkele muurtypes is een speciale plug misschien vereist!
(RU)	Обязательно установите крепление на стене во избежание опрокидывания! Для некоторых типов стен может потребоваться специальный дюбель!
(CZ)	Montáž na stěnu slouží jako ochrana proti převrnutí – bezpodmínečně umístěte! U některých typů stěn může být zapotřebí speciální hmoždinka!
(HU)	A terméket a falhoz kel rögzíteni, különben az felborulhat! Egyes faltípusoknál speciális tiplit kell használni!
(RO)	Sistemul de fixare la perete servește ca protecție la răsturnare - de montat obligatoriu! Pentru unele tipuri de pereți este posibil să fie necesar un diblu special!
(PL)	Mocowanie do ściany jest jednocześnie zabezpieczeniem przed przewróceniem – koniecznie zamontować! Do niektórych rodzajów ścian koniecznie zastosować specjalne kołki mocujące.
(SK)	Upevnenie na stenu slúži ako ochrana proti prevráteniu – bezpodmienečne použite! Pre niektoré druhy stien môže byť potrebná špeciálna hmoždinka!